



## Accessory (PERNOS) 71-E009-48-48

Floor mounting bolts



### TECHNICAL FEATURES

---

Structure material : Steel

Warranty : 2 Years

Structure finish : Galvanised steel

Seaside : Yes

### LOGISTICS

---

Net weight (kg): 0.2

Packaged weight (kg): 0.24

Packaging: 1mm x 1mm



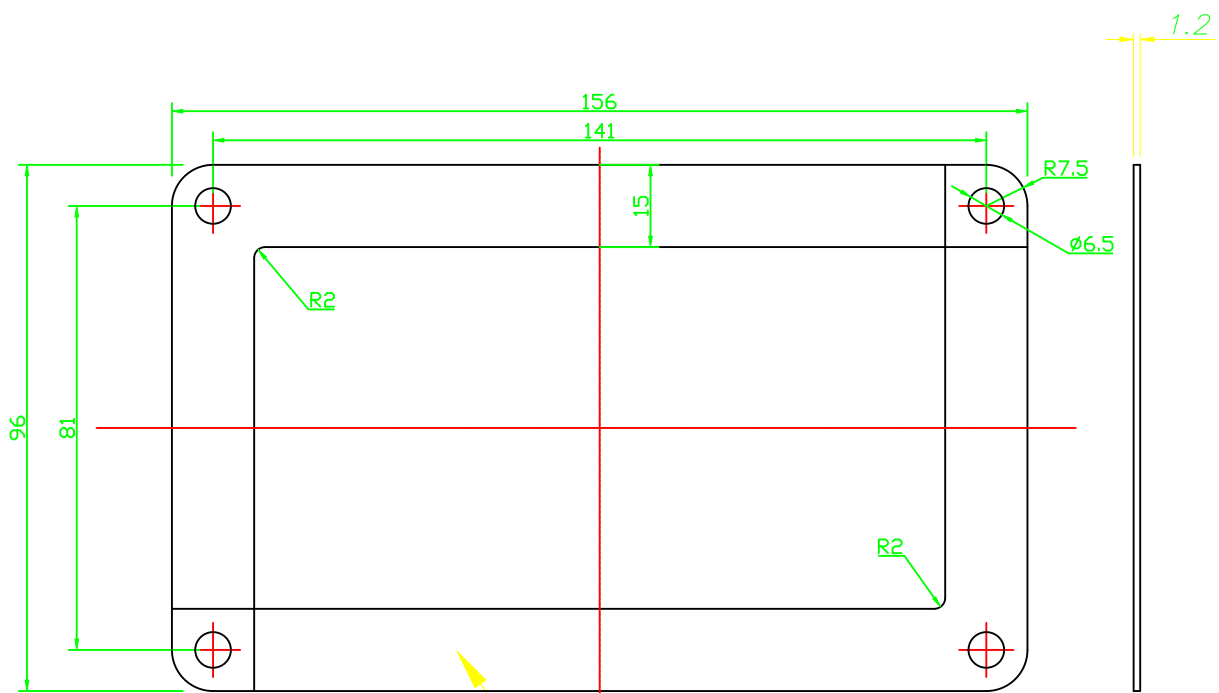

ACERO GALVANIZADO  
GALVANIZED STEEL

# LEDS C4<sup>+</sup>

71-E009

①

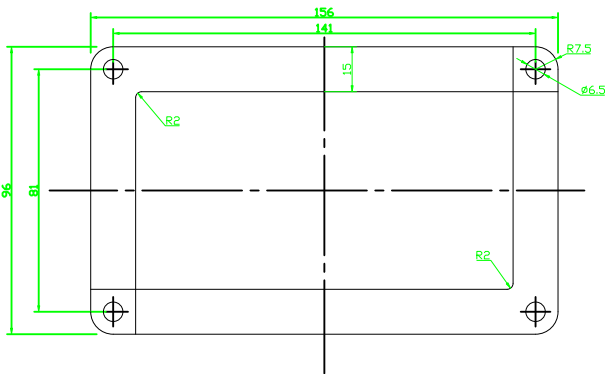

②

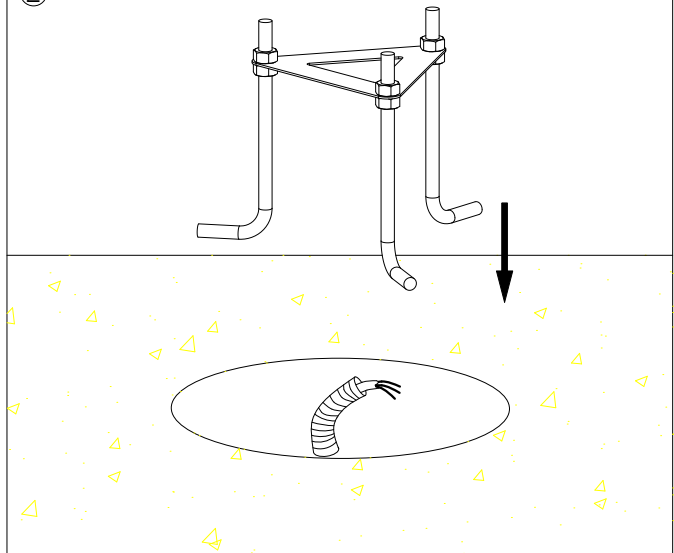

③

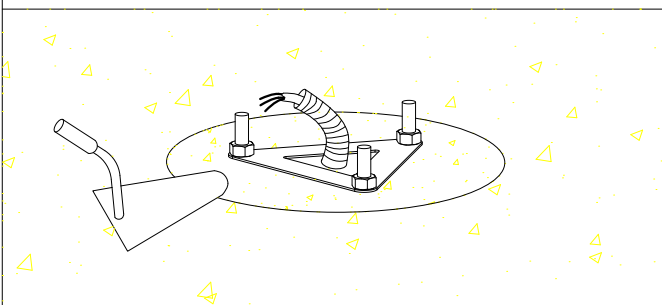

④

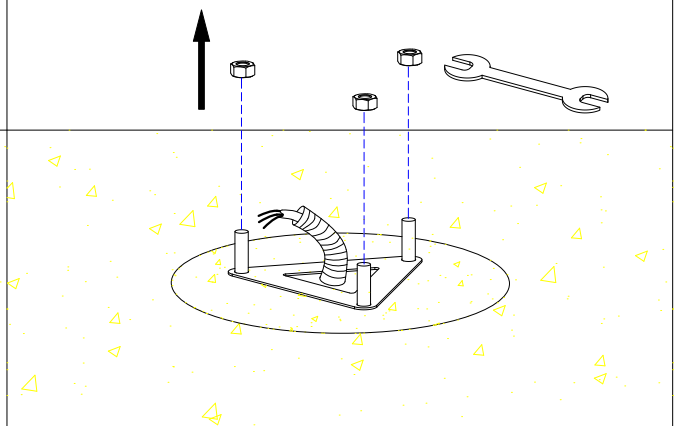

⑤A

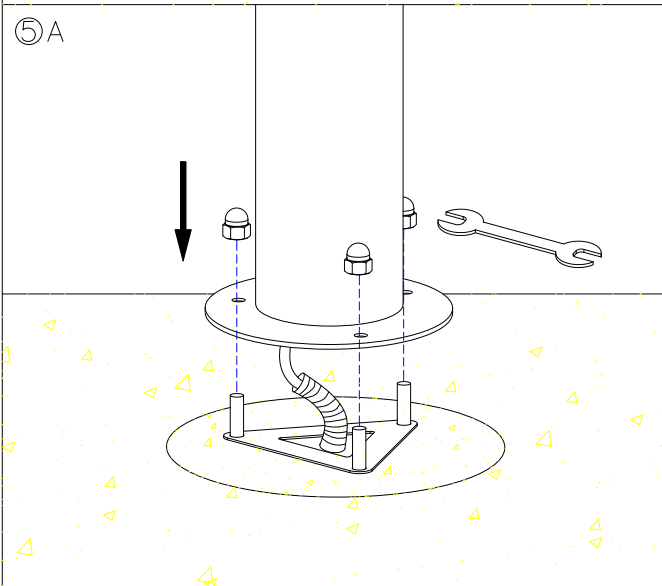

⑤B

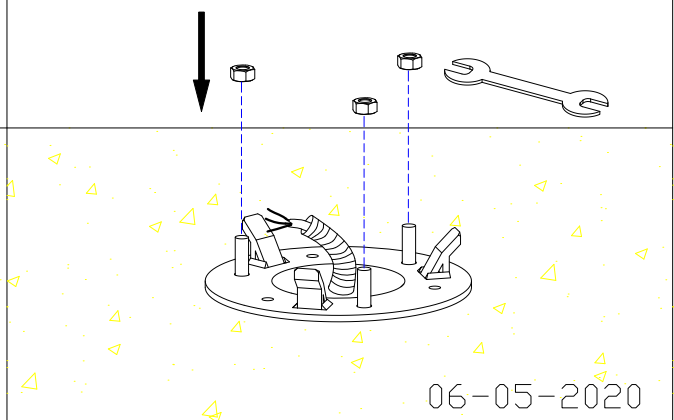

06-05-2020