



Noway Double Screen Floor lamp

Designer: Francesc Vilaró

Description

Floor lamp Noway Double Screen LED 18W 3000K Matte gold 495lm

	Finish	Material
Structure	Matte gold	Steel

 IP20
  HORIZONTAL 137°
  1

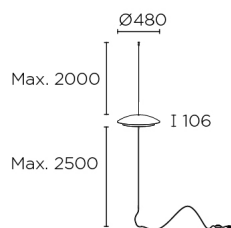

TECHNICAL CHARACTERISTICS

Light source

Light source: LED EDISON
 Light source power (W): 18W
 Luminaire total power (W): 18W
 Color temperature: LED warm-white
 3000K
 CRI: 80
 Photobiological risk: RG0
 Real Lumen: 495
 Qty Leds: 44
 Lm/Real W: 28
 Life Time: 50.000h L80B20
 Bin / Grup: 303
 MacAdam steps: 3
 UGR: 19.6
 Luminance C0°65°: 6111.4
 Luminance 90°65°: 6142.8

GEAR

Gear included: Yes, electronic
 Voltage / Frequency:
 220-240V/50-60Hz

Luminaire

Warranty: 5 Years

Logistics

Energy Efficiency: LED A++
 EAN Code: 8435575346932
 Net Weight (Kg): 4.43
 Weight in Kg (packaged): 8.39
 Masterbox: 1

The photograph may not match the reference exactly. Please read the product description to identify the finish.

LEDS C4²

Luminaire

Code 00-7979-DN-05
Name LIAR

Measurement

Code 00-7979-DN-05
Name LIAR

Luminaire Flux	495.17 lm	Luminaire Power	18.00 W	Efficacy	27.51 lm/W	Efficiency	100.00%
Sources Flux	495.17 lm	Maximum value	270.13 cd/klm	Position	C=0.00 G=0.00	CG	Double Symmetrical
Round Luminaire		Diam.	480 mm	Height	100 mm		
Round Luminous Area		Diam.	200 mm	Height	0 mm		
Horizontal Luminous Area	0.031416 m ²			Emitting area on Plane 180°	0.000000 m ²		
Emitting area on Plane 0°	0.000000 m ²			Emitting area on Plane 270°	0.000000 m ²		
Emitting area on Plane 90°	0.000000 m ²			Glare area at 76°	0.007600 m ²		
Coordinate system	CG			Symmetry Type	Double Symmetrical		
Date	24-10-2019			Maximum Gamma Angle	90		
Measurement Distance	0.00			Measurement Flux	495.17 lm		
Operator	qualitat			Rated Voltage			
Temperature	25.00 °C			Rated Current			
Humidity	60.00 %			Photocell			
Notes							

Luminaire Lamps

Line	Code	Name	Flux [lm]	Pow. [W]	Q.ty
	00-7979-DN-05	00-7977-DN-DN	495.17	18.00	1
C.I.E.	39 75 96 100 100	D DIN 5040	A20		
F UTE	1.00 E	B NBN	BZ 6 / 0.8 / BZ 5		

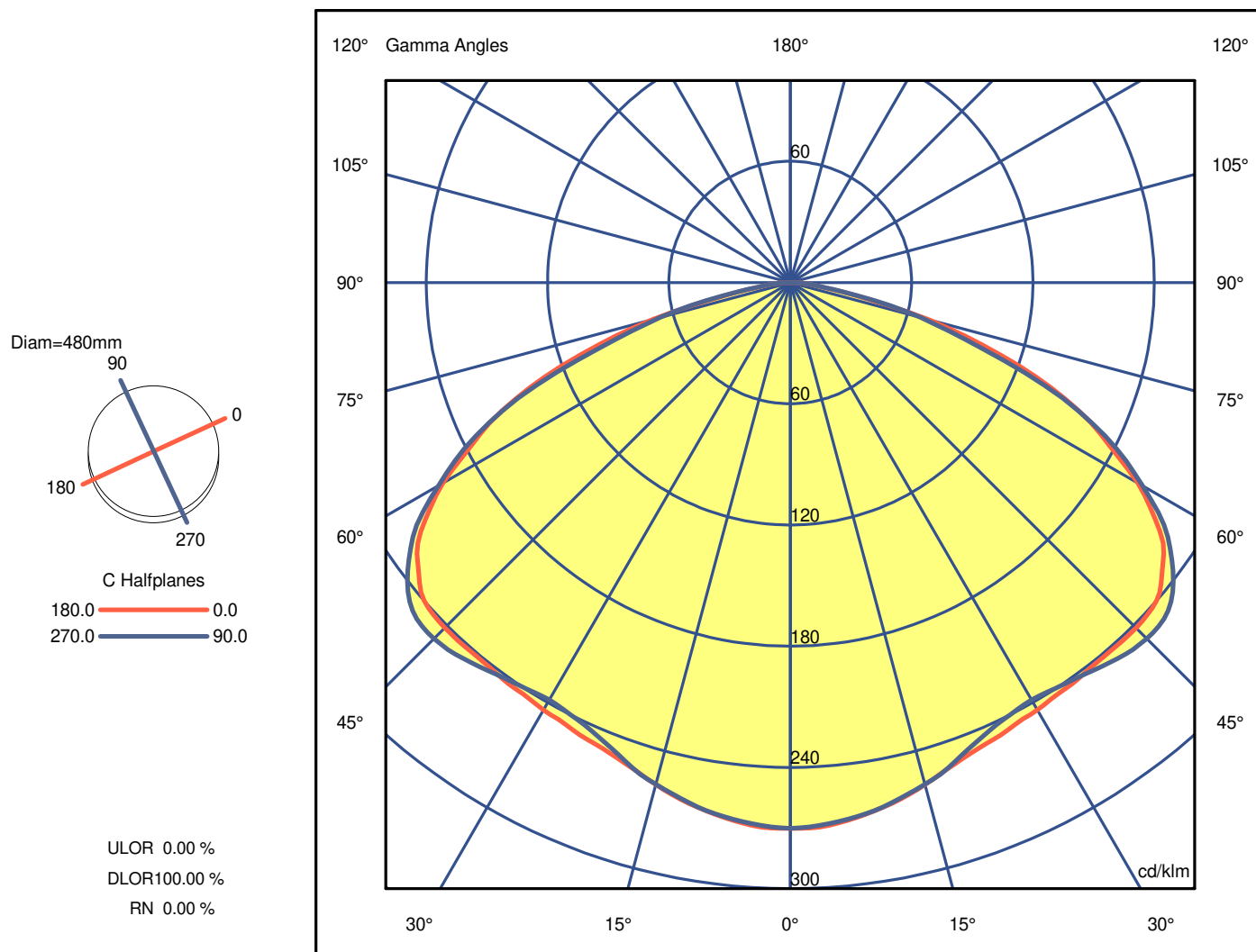

LEDS C4²

Luminaire

Code 00-7979-DN-05
Name LIAR

Measurem.

Code 00-7979-DN-05
Name LIAR

Luminaire Flux	495.17 lm	Luminaire Power	18.00 W	Efficacy	27.51 lm/W	Efficiency	100.00%
Sources Flux	495.17 lm	Maximum value	270.13 cd/klm	Position	C=0.00 G=0.00	CG	Double Symmetrical

Luminous Intensity Table cd/klm Table 1/1

	C 0.00	C 15.00	C 30.00	C 45.00	C 60.00	C 75.00	C 90.00
G 0.0	270.13	270.13	270.13	270.13	270.13	270.13	270.13
G 2.5	270.05	269.32	269.98	269.70	269.71	269.80	269.28
G 5.0	268.60	268.22	268.80	268.85	268.44	268.60	267.91
G 7.5	266.38	266.68	266.96	266.74	266.45	266.54	266.02
G 10.0	263.75	264.15	264.35	263.90	264.21	264.07	263.49
G 12.5	260.80	260.68	261.19	261.13	261.05	261.03	260.26
G 15.0	257.24	257.59	257.66	258.14	257.28	257.70	257.07
G 17.5	253.45	254.58	253.86	254.28	253.30	253.64	253.49
G 20.0	250.42	251.27	250.73	250.50	249.10	249.93	248.58
G 22.5	248.21	248.45	247.61	247.88	245.52	246.42	244.52
G 25.0	246.92	246.66	244.88	245.40	242.75	243.94	241.41
G 27.5	244.93	245.33	243.03	242.98	240.75	241.84	239.48
G 30.0	244.21	243.61	241.86	242.04	239.86	241.30	238.43
G 32.5	242.89	242.49	241.58	242.14	240.48	242.06	239.44
G 35.0	242.56	242.16	241.35	242.81	241.88	243.40	240.88
G 37.5	241.70	241.90	241.80	243.32	243.86	245.24	242.97
G 40.0	241.41	241.78	242.75	244.75	245.95	247.12	245.52
G 42.5	241.58	242.00	243.88	245.66	247.88	248.86	247.92
G 45.0	241.66	241.90	244.49	245.92	248.97	249.45	249.18
G 47.5	240.98	241.14	243.78	245.09	248.36	248.56	248.93
G 50.0	238.37	238.60	241.28	241.26	245.59	244.76	245.72
G 52.5	231.90	232.35	234.97	234.33	238.03	236.93	238.67
G 55.0	224.99	224.78	226.36	224.74	226.57	227.85	229.31
G 57.5	212.54	214.07	213.66	213.46	214.45	214.40	217.52
G 60.0	198.33	200.14	200.23	198.35	202.34	201.47	200.93
G 62.5	180.18	181.52	182.77	182.62	185.03	182.19	184.61
G 65.0	163.87	165.06	163.83	163.75	162.68	164.88	164.71
G 67.5	143.51	143.36	141.50	142.14	138.59	139.00	140.92
G 70.0	120.48	118.22	115.52	114.02	115.19	115.86	112.10
G 72.5	94.78	91.89	90.59	89.43	90.54	89.16	86.34
G 75.0	70.98	70.66	68.64	69.31	66.03	69.24	66.75
G 77.5	44.78	47.45	47.08	48.21	45.76	45.08	46.60
G 80.0	25.69	27.14	30.04	26.31	30.64	26.12	26.93
G 82.5	15.33	14.59	15.51	14.51	16.40	14.53	15.31
G 85.0	9.92	9.71	9.69	9.66	9.90	9.86	10.22
G 87.5	5.87	5.71	5.88	6.04	5.77	5.74	5.87
G 90.0	3.53	3.71	3.67	3.61	3.49	3.41	3.46

LEDS C4²

Luminaire

Code 00-7979-DN-05
Name LIAR

Measurement

Code 00-7979-DN-05
Name LIAR

Luminaire Flux	495.17 lm	Luminaire Power	18.00 W	Efficacy	27.51 lm/W	Efficiency	100.00%
Sources Flux	495.17 lm	Maximum value	270.13 cd/klm	Position	C=0.00 G=0.00	CG	Double Symmetrical

Diam=480mm

C Halfplanes

180.0 ———— 0.0
270.0 ———— 90.0

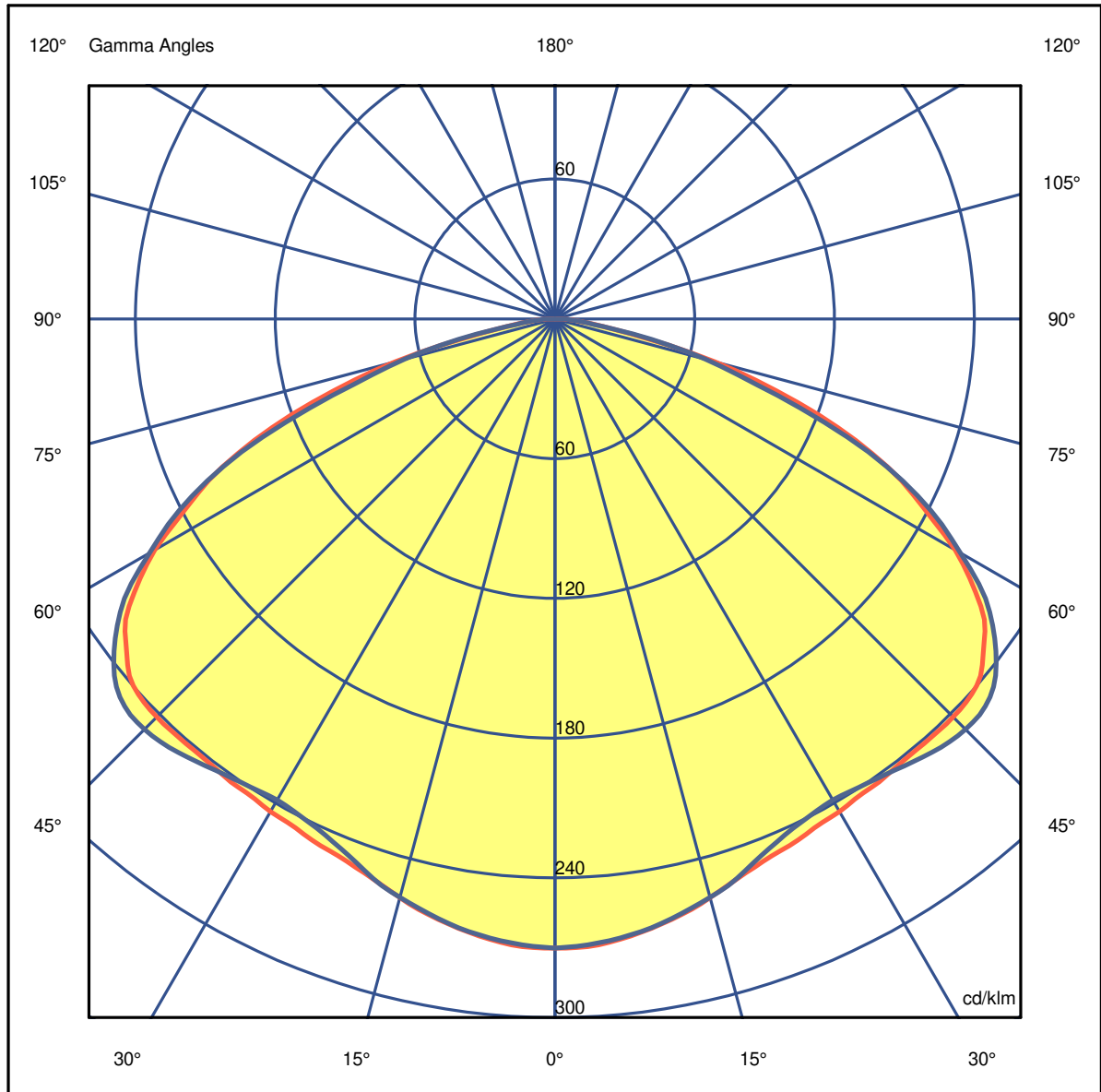
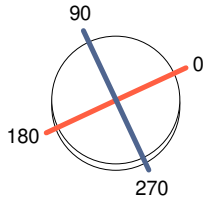

LEDS C4[®]

Luminaire

Code 00-7979-DN-05
 Name LIAR

Measurement

Code 00-7979-DN-05
 Name LIAR

Luminaire Flux	495.17 lm	Luminaire Power	18.00 W	Efficacy	27.51 lm/W	Efficiency	100.00%
Sources Flux	495.17 lm	Maximum value	270.13 cd/klm	Position	C=0.00 G=0.00	CG	Double Symmetrical

Diam=480mm

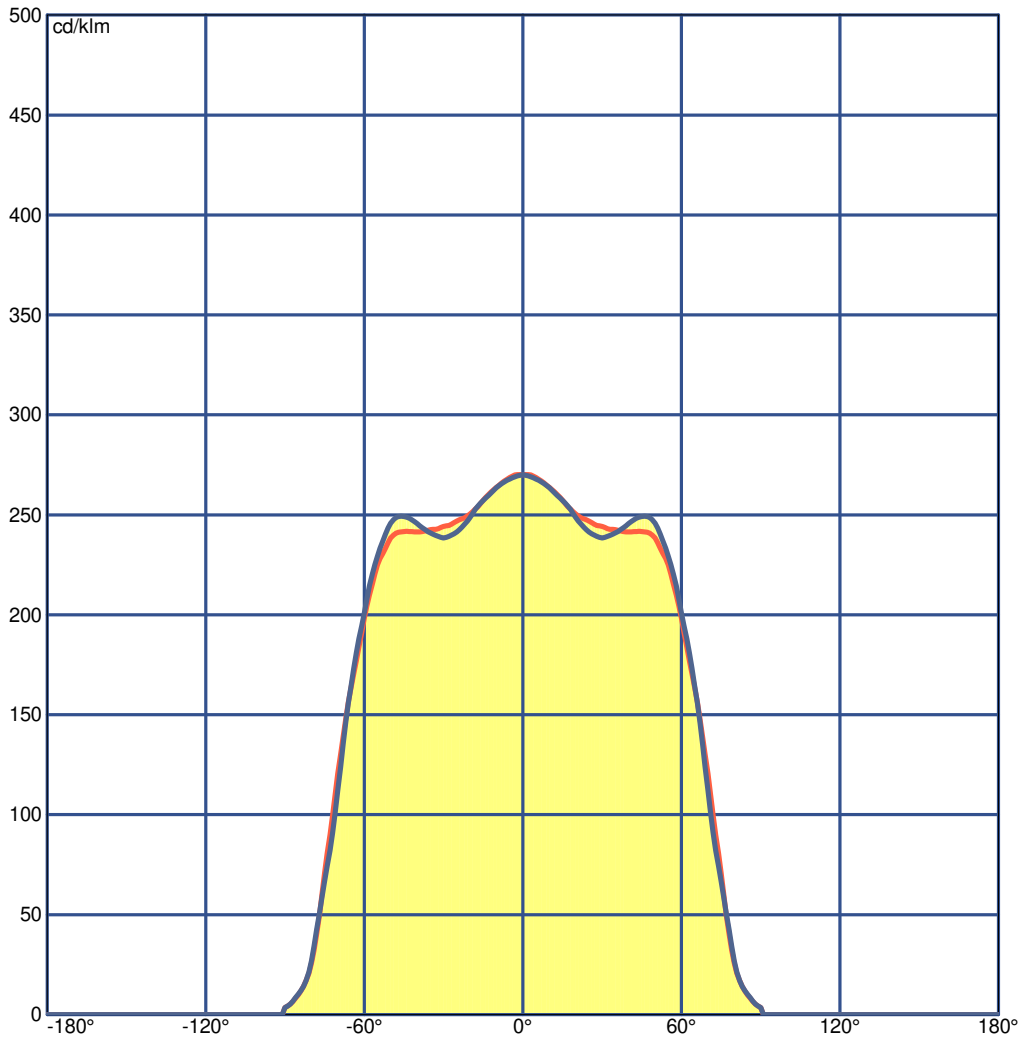
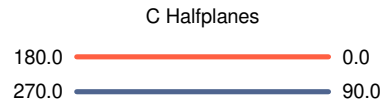
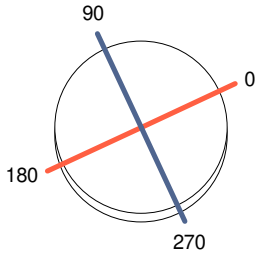

LEDS C4[®]

Luminaire

Code 00-7979-DN-05
Name LIAR

Measurement

Code 00-7979-DN-05
Name LIAR

Luminaire Flux	495.17 lm	Luminaire Power	18.00 W	Efficacy	27.51 lm/W	Efficiency	100.00%
Sources Flux	495.17 lm	Maximum value	270.13 cd/klm	Position	C=0.00 G=0.00	CG	Double Symmetrical

UGR
S = 0.250

Reflectancies										
Ceiling/Cavity	0.7	0.7	0.5	0.5	0.3	0.7	0.7	0.5	0.5	0.3
Walls	0.5	0.3	0.5	0.3	0.3	0.5	0.3	0.5	0.3	0.3
WorkingPlane	0.2	0.2	0.2	0.2	0.2	0.2	0.2	0.2	0.2	0.2
RoomDimensions	Viewed Crosswise					Viewed Endwise				
x=2H y=2H	19.4	20.8	19.7	21.1	21.3	19.5	20.9	19.8	21.2	21.4
x=2H y=3H	21.2	22.5	21.5	22.7	23.0	21.1	22.4	21.5	22.7	23.0
x=2H y=4H	21.7	22.9	22.0	23.2	23.5	21.6	22.8	21.9	23.1	23.4
x=2H y=6H	21.8	23.0	22.2	23.3	23.6	21.8	22.9	22.1	23.2	23.5
x=2H y=8H	21.8	22.9	22.2	23.3	23.6	21.8	22.9	22.2	23.2	23.5
x=2H y=12H	21.8	22.9	22.2	23.2	23.5	21.8	22.8	22.2	23.1	23.5
x=4H y=2H	20.3	21.5	20.6	21.8	22.1	20.3	21.6	20.7	21.8	22.1
x=4H y=3H	22.1	23.1	22.5	23.5	23.8	22.1	23.1	22.5	23.5	23.8
x=4H y=4H	22.7	23.6	23.1	24.0	24.3	22.6	23.5	23.0	23.9	24.3
x=4H y=6H	22.9	23.7	23.3	24.1	24.5	22.9	23.7	23.3	24.0	24.4
x=4H y=8H	23.0	23.7	23.4	24.1	24.5	22.9	23.6	23.3	24.0	24.4
x=4H y=12H	23.0	23.6	23.4	24.0	24.5	22.9	23.6	23.3	24.0	24.4
x=8H y=4H	22.9	23.7	23.4	24.1	24.5	22.8	23.6	23.3	24.0	24.4
x=8H y=6H	23.2	23.8	23.7	24.3	24.7	23.2	23.8	23.6	24.2	24.7
x=8H y=8H	23.3	23.8	23.8	24.3	24.7	23.2	23.7	23.7	24.2	24.7
x=8H y=12H	23.3	23.8	23.8	24.2	24.7	23.3	23.7	23.7	24.2	24.7
x=12H y=4H	22.9	23.6	23.4	24.0	24.4	22.8	23.5	23.3	23.9	24.4
x=12H y=6H	23.2	23.8	23.7	24.2	24.7	23.2	23.7	23.6	24.1	24.6
x=12H y=8H	23.3	23.7	23.8	24.2	24.7	23.2	23.7	23.7	24.1	24.6

LEDS C4⁺

Luminaire

Code 00-7979-DN-05
Name LIAR

Measurum.

Code 00-7979-DN-05
Name LIAR

Luminaire Flux	495.17 lm	Luminaire Power	18.00 W	Efficacy	27.51 lm/W	Efficiency	100.00%
Sources Flux	495.17 lm	Maximum value	270.13 cd/klm	Position	C=0.00 G=0.00	CG	Double Symmetrical

Total Flux=495.17 Luminaire Flux=495.17

RI	0.60	0.80	1.00	1.25	1.50	2.00	2.50	3.00	4.00	5.00	10.00	20.00
DRR	0.24	0.33	0.41	0.49	0.55	0.65	0.71	0.76	0.81	0.85	0.92	0.96
RC	7	6	6	6	6	6	6	6	5	5	5	4

Zonal Flux per 1000 Lumen

Y°	10	20	30	40	50	60	70	80	90	100	110	120	130	140	150	160	170	180
ZF(Y)	25	98	212	364	554	755	914	987	1000	1000	1000	1000	1000	1000	1000	1000	1000	1000

CIE Flux Codes

39 75 96 100 100

C.I.E. 7/6/6/6/6/6/6/5/5/4
D DIN 5040 A20
F UTE 1.00 E
B NBN BZ 6 / 0.8 / BZ 5
RN 0.00000 %
BLF 1.0

LOR 100.00000 %
ULOR 0.00000 %
DLOR 100.00000 %
UFF 0.00000 %
DFF 100.00000 %
FFR 0.00000 %

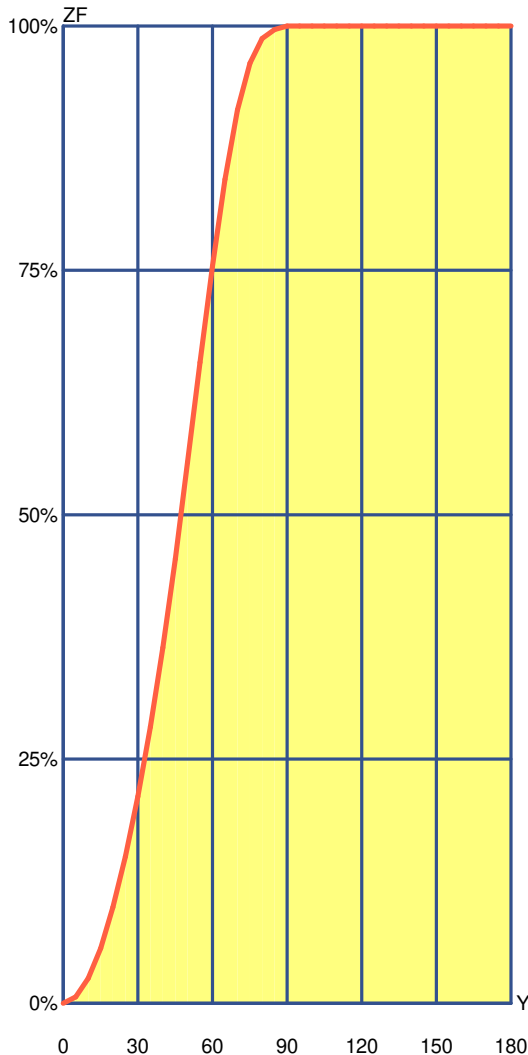

Gamma °	Zonal Flux			
	Flux	Sum lm	Flux [%]	Sum [%]
0°	0.00	0.00	0.00%	0.00%
5°	6.44	6.44	0.64%	0.64%
10°	19.05	25.49	1.90%	2.55%
15°	30.93	56.42	3.09%	5.64%
20°	41.82	98.24	4.18%	9.82%
25°	51.84	150.09	5.18%	15.01%
30°	61.48	211.56	6.15%	21.16%
35°	71.21	282.78	7.12%	28.28%
40°	81.15	363.92	8.11%	36.39%
45°	90.85	454.78	9.09%	45.48%
50°	98.89	553.67	9.89%	55.37%
55°	102.07	655.74	10.21%	65.57%
60°	98.77	754.51	9.88%	75.45%
65°	88.68	843.19	8.87%	84.32%
70°	71.12	914.31	7.11%	91.43%
75°	47.71	962.01	4.77%	96.20%
80°	25.35	987.36	2.53%	98.74%
85°	9.21	996.57	0.92%	99.66%
90°	3.43	1000.00	0.34%	100.00%
95°	0.00	1000.00	0.00%	100.00%
100°	0.00	1000.00	0.00%	100.00%
105°	0.00	1000.00	0.00%	100.00%
110°	0.00	1000.00	0.00%	100.00%
115°	0.00	1000.00	0.00%	100.00%
120°	0.00	1000.00	0.00%	100.00%
125°	0.00	1000.00	0.00%	100.00%
130°	0.00	1000.00	0.00%	100.00%
135°	0.00	1000.00	0.00%	100.00%
140°	0.00	1000.00	0.00%	100.00%
145°	0.00	1000.00	0.00%	100.00%
150°	0.00	1000.00	0.00%	100.00%
155°	0.00	1000.00	0.00%	100.00%
160°	0.00	1000.00	0.00%	100.00%
165°	0.00	1000.00	0.00%	100.00%
170°	0.00	1000.00	0.00%	100.00%
175°	0.00	1000.00	0.00%	100.00%
180°	0.00	1000.00	0.00%	100.00%

LEDS C4⁺

Luminaire

Code 00-7979-DN-05
Name LIAR

Measurement

Code 00-7979-DN-05
Name LIAR

Luminaire Flux	495.17 lm	Luminaire Power	18.00 W	Efficacy	27.51 lm/W	Efficiency	100.00%
Sources Flux	495.17 lm	Maximum value	270.13 cd/klm	Position	C=0.00 G=0.00	CG	Double Symmetrical

Utilizations CIE

Mounting	Direct	Normalization										Normalised										Suspension Ratid/3										Standard CIE Settings									
		Ceiling																																							
K		8873	8773	8871	8771	7773	7771	7753	7553	7751	7551	7731	7331	7711	7111	5551	5531	5331	5511	5111	3331	3311	1111	0000																	
0.60		226	203	184	166	193	158	114	97	93	79	49	37	17	12	74	39	35	14	11	33	12	10	0																	
0.80		261	239	196	181	228	173	143	125	106	93	59	47	23	17	87	49	44	19	16	42	17	15	0																	
1.00		284	264	198	185	251	177	166	148	113	102	66	54	29	22	95	56	51	25	21	49	22	19	0																	
1.25		303	285	194	184	271	177	189	171	118	108	72	61	35	28	101	62	58	31	27	55	27	25	0																	
1.50		316	300	189	181	286	174	207	191	120	111	76	66	41	34	105	67	63	36	32	60	33	30	0																	
2.00		332	319	176	170	304	165	235	220	120	113	82	74	50	43	107	74	70	46	42	67	42	39	0																	
2.50		343	332	166	162	317	157	256	242	119	113	86	79	58	51	108	79	75	53	49	72	49	46	0																	
3.00		350	340	158	154	325	150	271	258	117	113	89	82	64	57	108	82	79	59	55	76	55	52	0																	
4.00		360	352	147	145	337	141	293	282	116	112	93	88	72	66	108	87	84	68	64	82	64	60	0																	
5.00		366	360	141	139	345	136	307	298	115	112	95	91	78	73	108	90	88	74	70	85	70	67	0																	
10.00		379	376	125	124	361	122	340	335	111	110	101	99	91	88	107	97	96	88	86	93	84	82	0																	
20.00		386	385	117	116	370	115	359	356	109	109	104	103	99	97	106	101	100	96	95	98	93	91	0																	

Wall

K		8873	8773	8871	8771	7773	7771	7753	7553	7751	7551	7731	7331	7711	7111	5551	5531	5331	5511	5111	3331	3311	1111	0000
0.60		498	485	444	435	479	430	377	369	347	341	291	287	251	249	338	287	285	249	249	284	249	248	228
0.80		561	548	486	478	538	472	438	429	393	387	338	332	296	293	382	332	330	294	292	328	292	291	268
1.00		603	591	511	503	578	496	482	472	424	417	370	364	328	325	411	364	361	326	324	359	324	322	296
1.25		639	627	527	520	612	513	522	512	448	442	398	392	358	354	435	390	388	354	352	385	352	350	320
1.50		664	653	537	531	636	523	552	541	464	459	418	412	379	375	451	410	407	376	373	404	372	370	338
2.00		688	678	537	533	659	525	587	576	477	472	437	431	403	399	463	428	426	398	396	421	394	390	354
2.50		702	693	534	531	672	522	609	598	482	478	447	442	417	413	468	438	436	411	409	430	406	402	363
3.00		708	701	528	526	678	518	622	613	483	479	452	448	425	421	469	443	441	419	416	434	413	408	367
4.00		720	713	523	521	689	513	643	634	486	483	461	457	439	434	472	451	449	431	429	442	424	418	374
5.00		727	722	520	518	696	511	657	649	488	486	467	464	448	444	475	456	455	440	437	447	432	425	379
10.00		736	733	506	505	705	498	682	678	486	484	474	472	463	460	473	462	461	452	451	452	443	434	384
20.00		725	723	481	481	692	474	680	678	468	467	461	460	455	453	455	449	449	444	443	438	433	423	371

Working Pl.

K		8873	8773	8871	8771	7773	7771	7753	7553	7751	7551	7731	7331	7711	7111	5551	5531	5331	5511	5111	3331	3311	1111	0000
0.60		545	532	508	498	523	492	400	392	385	379	313	308	261	259	375	308	307	259	258	305	258	258	239
0.80		660	645	608	597	632	589	508	498	485	478	411	405	355	352	471	404	402	353	351	399	351	350	330
1.00		749	734	683	673	718	663	597	585	565	557	492	485	436	432	548	484	481	432	430	477	430	428	408
1.25		835	820	752	743	800	732	686	673	642	635	573	565	518	513	624	563	560	513	511	555	510	507	488
1.50		899	884	803	795	861	782	754	740	701	693	636	628	583	577	680	624	621	577	574	614	572	568	550
2.00		991	978	873	867	950	854	858	844	786	780	730	722	683	676	765	716	713	675	671	705	668	663	646
2.50		1000	1000	917	912	1000	899	927	914	842	836	793	785	750	744	819	777	774	741	737	765	732	725	709
3.00		1000	1000	947	943	1000	929	977	965	880	875	837	830	799	792	858	821	818	788	784	807	778	770	755
4.00		1000	1000	983	980	1000	967	1000	1000	928	924	893	887	862	855	905	876	873	849	845	860	837	826	813
5.00		1000	1000	1000	1000	1000	989	1000	1000	957	953	928	922	901	895	934	909	907	886	883	893	873	861	848
10.00		1000	1000	1000	1000	1000	1000	1000	1000	1000	1000	1000	1000	997	985	981	993	980	979	967	965	961	950	935
20.00		1000	1000	1000	1000	1000	1000	1000	1000	1000	1000	1000	1000	1000	1000	1000	1000	1000	1000	1000	997	992	974	963

LM53 SHR C0-C180: 1.375 SHR C90-C270: 1.362 SHR Square: 1.643

LEDS C4²

Luminaire

Code 00-7979-DN-05
Name LIAR

Measurem.

Code 00-7979-DN-05
Name LIAR

Luminaire Flux	495.17 lm	Luminaire Power	18.00 W	Efficacy	27.51 lm/W	Efficiency	100.00%
Sources Flux	495.17 lm	Maximum value	270.13 cd/klm	Position	C=0.00 G=0.00	CG	Double Symmetrical

Width at 50.00 % of Max Intensity

H[m]	1.00	2.00	3.00	4.00	5.00	H[m]	1.00	2.00	3.00	4.00	5.00
OA	2.53	5.06	7.60	10.13	12.66	OC	2.48	4.96	7.44	9.91	12.39
OB	2.53	5.06	7.60	10.13	12.66	OD	2.48	4.96	7.44	9.91	12.39

	Luminous Intensities [cd/klm]									
	0	5	15	25	35	45	55	65	75	85
OA	133.76	133.00	127.38	122.27	120.11	119.66	111.41	81.14	35.15	4.91
OB	133.76	133.00	127.38	122.27	120.11	119.66	111.41	81.14	35.15	4.91
OC	133.76	132.66	127.30	119.54	119.27	123.39	113.55	81.56	33.05	5.06
OD	133.76	132.66	127.30	119.54	119.27	123.39	113.55	81.56	33.05	5.06

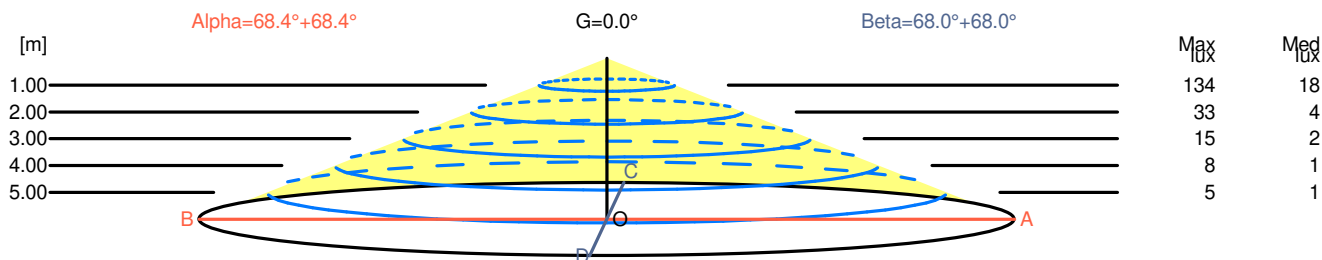

H[m]	D[m]	Max lux	Med lux	Alpha=68.4°+68.4°	G=0.0
1.00	5.06	134	18		
2.00	10.13	33	4		
3.00	15.19	15	2		
4.00	20.25	8	1		
5.00	25.32	5	1		

H[m]	D[m]	Max lux	Med lux	Beta=68.0°+68.0°	G=0.0
1.00	4.96	134	18		
2.00	9.91	33	4		
3.00	14.87	15	2		
4.00	19.83	8	1		
5.00	24.79	5	1		

LEDS C4²

Luminaire

Code 00-7979-DN-05
Name LIAR

Measur.

Code 00-7979-DN-05
Name LIAR

Luminaire Flux	495.17 lm	Luminaire Power	18.00 W	Efficacy	27.51 lm/W	Efficiency	100.00%
Sources Flux	495.17 lm	Maximum value	270.13 cd/klm	Position	C=0.00 G=0.00	CG	Double Symmetrical

Isolux (Floor)

Luminaire position X=0.00m Y=0.00m Z=2.50m

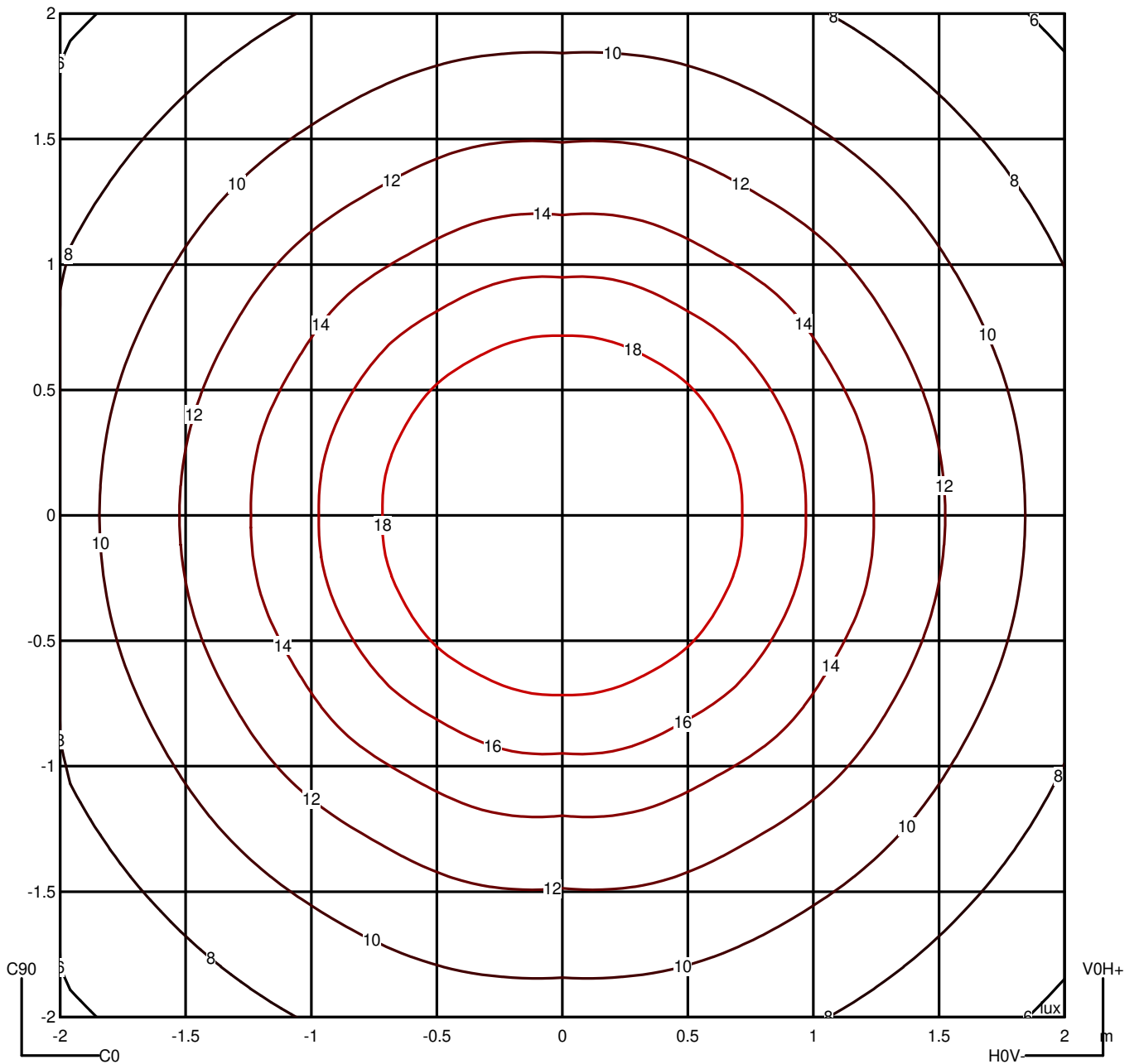

LEDS C4[®]

Luminaire

Code 00-7979-DN-05
 Name LIAR

Measurem.

Code 00-7979-DN-05
 Name LIAR

Luminaire Flux	495.17 lm	Luminaire Power	18.00 W	Efficacy	27.51 lm/W	Efficiency	100.00%
Sources Flux	495.17 lm	Maximum value	270.13 cd/klm	Position	C=0.00 G=0.00	CG	Double Symmetrical

Luminance

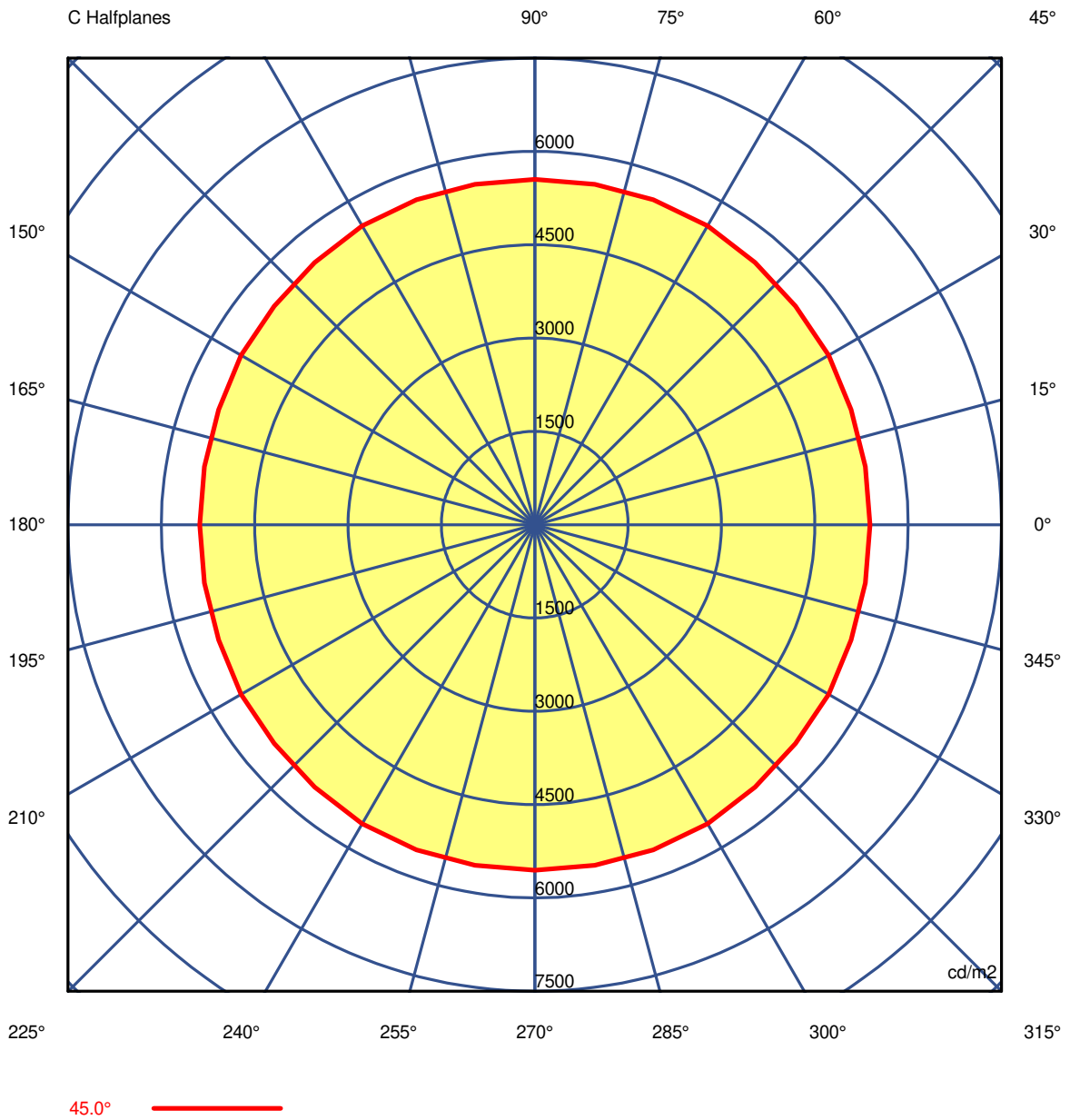

LEDS C4²

Luminaire

Code 00-7979-DN-05

Name LIAR

Measurement

Code 00-7979-DN-05

Name LIAR

Luminaire Flux	495.17 lm	Luminaire Power	18.00 W	Efficacy	27.51 lm/W	Efficiency	100.00%
Sources Flux	495.17 lm	Maximum value	270.13 cd/klm	Position	C=0.00 G=0.00	CG	Double Symmetrical

Luminance cd/m2 Table 1/3

	C 0.00	C 10.00	C 20.00	C 30.00	C 40.00	C 50.00	C 60.00	C 70.00	C 80.00	C 90.00	C 100.00	C 110.00	C 120.00
G 0.0	4257.70	4257.70	4257.70	4257.70	4257.70	4257.70	4257.70	4257.70	4257.70	4257.70	4257.70	4257.70	4257.70
G 5.0	4249.83	4244.13	4245.98	4252.98	4255.10	4251.28	4247.32	4249.37	4247.65	4238.79	4247.65	4249.37	4247.32
G 10.0	4221.35	4225.56	4229.84	4230.82	4225.42	4224.41	4228.70	4228.38	4223.73	4217.21	4223.73	4228.38	4228.70
G 15.0	4197.50	4202.28	4203.71	4204.39	4211.55	4208.17	4198.28	4202.56	4204.10	4194.87	4204.10	4202.56	4198.28
G 20.0	4200.44	4212.52	4212.59	4205.62	4205.12	4193.17	4178.23	4187.80	4189.37	4169.55	4189.37	4187.80	4178.23
G 25.0	4294.16	4291.17	4277.91	4258.82	4268.64	4253.40	4221.74	4235.61	4236.41	4198.36	4236.41	4235.61	4221.74
G 30.0	4444.60	4440.77	4421.64	4401.92	4407.29	4391.53	4365.43	4384.42	4384.26	4339.44	4384.26	4384.42	4365.43
G 35.0	4667.30	4664.51	4651.40	4643.94	4665.42	4667.19	4654.16	4675.98	4676.51	4634.83	4676.51	4675.98	4654.16
G 40.0	4967.09	4971.59	4978.82	4994.75	5022.89	5045.21	5060.64	5080.74	5079.40	5051.71	5079.40	5080.74	5060.64
G 45.0	5386.65	5390.20	5409.50	5449.88	5469.03	5503.39	5549.71	5562.27	5558.23	5554.34	5558.23	5562.27	5549.71
G 50.0	5844.95	5848.73	5874.01	5916.46	5908.65	5948.32	6022.12	6008.50	6000.89	6025.21	6000.89	6008.50	6022.12
G 55.0	6182.57	6170.86	6194.25	6220.38	6188.04	6183.30	6226.06	6251.88	6272.86	6301.46	6272.86	6251.88	6226.06
G 60.0	6251.94	6292.07	6321.36	6311.93	6272.50	6286.83	6378.39	6360.26	6345.51	6334.15	6345.51	6360.26	6378.39
G 65.0	6111.44	6151.60	6143.99	6110.29	6108.16	6090.13	6067.10	6120.87	6159.64	6142.84	6159.64	6120.87	6067.10
G 70.0	5552.01	5485.23	5406.58	5323.60	5264.56	5261.97	5308.33	5348.09	5300.63	5165.91	5300.63	5348.09	5308.33
G 75.0	4322.39	4309.44	4254.60	4179.82	4227.50	4151.63	4021.36	4151.10	4213.28	4064.93	4213.28	4151.10	4021.36
G 80.0	2331.89	2383.15	2591.14	2726.77	2454.81	2495.55	2780.70	2530.64	2319.36	2444.21	2319.36	2530.64	2780.70
G 85.0	1793.22	1764.39	1753.70	1753.27	1743.89	1760.98	1790.93	1784.07	1795.89	1847.85	1795.89	1784.07	1790.93
G 90.0	0.00	0.00	0.00	0.00	0.00	0.00	0.00	0.00	0.00	0.00	0.00	0.00	0.00

LEDS C4²

Luminaire

Code 00-7979-DN-05
Name LIAR

Measurement

Code 00-7979-DN-05
Name LIAR

Luminaire Flux	495.17 lm	Luminaire Power	18.00 W	Efficacy	27.51 lm/W	Efficiency	100.00%
Sources Flux	495.17 lm	Maximum value	270.13 cd/klm	Position	C=0.00 G=0.00	CG	Double Symmetrical

Luminance cd/m2 Table 2/3

	C 130.00	C 140.00	C 150.00	C 160.00	C 170.00	C 180.00	C 190.00	C 200.00	C 210.00	C 220.00	C 230.00	C 240.00	C 250.00
G 0.0	4257.70	4257.70	4257.70	4257.70	4257.70	4257.70	4257.70	4257.70	4257.70	4257.70	4257.70	4257.70	4257.70
G 5.0	4251.28	4255.10	4252.98	4245.98	4244.13	4249.83	4244.13	4245.98	4252.98	4255.10	4251.28	4247.32	4249.37
G 10.0	4224.41	4225.42	4230.82	4229.84	4225.56	4221.35	4225.56	4229.84	4230.82	4225.42	4224.41	4228.70	4228.38
G 15.0	4208.17	4211.55	4204.39	4203.71	4202.28	4197.50	4202.28	4203.71	4204.39	4211.55	4208.17	4198.28	4202.56
G 20.0	4193.17	4205.12	4205.62	4212.59	4212.52	4200.44	4212.52	4212.59	4205.62	4205.12	4193.17	4178.23	4187.80
G 25.0	4253.40	4268.64	4258.82	4277.91	4291.17	4294.16	4291.17	4277.91	4258.82	4268.64	4253.40	4221.74	4235.61
G 30.0	4391.53	4407.29	4401.92	4421.64	4440.77	4444.60	4440.77	4421.64	4401.92	4407.29	4391.53	4365.43	4384.42
G 35.0	4667.19	4665.42	4643.94	4651.40	4664.51	4667.30	4664.51	4651.40	4643.94	4665.42	4667.19	4654.16	4675.98
G 40.0	5045.21	5022.89	4994.75	4978.82	4971.59	4967.09	4971.59	4978.82	4994.75	5022.89	5045.21	5060.64	5080.74
G 45.0	5503.39	5469.03	5449.88	5409.50	5390.20	5386.65	5390.20	5409.50	5449.88	5469.03	5503.39	5549.71	5562.27
G 50.0	5948.32	5908.65	5916.46	5874.01	5848.73	5844.95	5848.73	5874.01	5916.46	5908.65	5948.32	6022.12	6008.50
G 55.0	6183.30	6188.04	6220.38	6194.25	6170.86	6182.57	6170.86	6194.25	6220.38	6188.04	6183.30	6226.06	6251.88
G 60.0	6286.83	6272.50	6311.93	6321.36	6292.07	6251.94	6292.07	6321.36	6311.93	6272.50	6286.83	6378.39	6360.26
G 65.0	6090.13	6108.16	6110.29	6143.99	6151.60	6111.44	6151.60	6143.99	6110.29	6108.16	6090.13	6067.10	6120.87
G 70.0	5261.97	5264.56	5323.60	5406.58	5485.23	5552.01	5485.23	5406.58	5323.60	5264.56	5261.97	5308.33	5348.09
G 75.0	4151.63	4227.50	4179.82	4254.60	4309.44	4322.39	4309.44	4254.60	4179.82	4227.50	4151.63	4021.36	4151.10
G 80.0	2495.55	2454.81	2726.77	2591.14	2383.15	2331.89	2383.15	2591.14	2726.77	2454.81	2495.55	2780.70	2530.64
G 85.0	1760.98	1743.89	1753.27	1753.70	1764.39	1793.22	1764.39	1753.70	1753.27	1743.89	1760.98	1790.93	1784.07
G 90.0	0.00	0.00	0.00	0.00	0.00	0.00	0.00	0.00	0.00	0.00	0.00	0.00	0.00

LEDS C4[®]

Luminaire

Code 00-7979-DN-05

Name LIAR

Measurem.

Code 00-7979-DN-05

Name LIAR

Luminaire Flux	495.17 lm	Luminaire Power	18.00 W	Efficacy	27.51 lm/W	Efficiency	100.00%
Sources Flux	495.17 lm	Maximum value	270.13 cd/klm	Position	C=0.00 G=0.00	CG	Double Symmetrical

Luminance cd/m2 Table 3/3

	C 260.00	C 270.00	C 280.00	C 290.00	C 300.00	C 310.00	C 320.00	C 330.00	C 340.00	C 350.00
G 0.0	4257.70	4257.70	4257.70	4257.70	4257.70	4257.70	4257.70	4257.70	4257.70	4257.70
G 5.0	4247.65	4238.79	4247.65	4249.37	4247.32	4251.28	4255.10	4252.98	4245.98	4244.13
G 10.0	4223.73	4217.21	4223.73	4228.38	4228.70	4224.41	4225.42	4230.82	4229.84	4225.56
G 15.0	4204.10	4194.87	4204.10	4202.56	4198.28	4208.17	4211.55	4204.39	4203.71	4202.28
G 20.0	4189.37	4169.55	4189.37	4187.80	4178.23	4193.17	4205.12	4205.62	4212.59	4212.52
G 25.0	4236.41	4198.36	4236.41	4235.61	4221.74	4253.40	4268.64	4258.82	4277.91	4291.17
G 30.0	4384.26	4339.44	4384.26	4384.42	4365.43	4391.53	4407.29	4401.92	4421.64	4440.77
G 35.0	4676.51	4634.83	4676.51	4675.98	4654.16	4667.19	4665.42	4643.94	4651.40	4664.51
G 40.0	5079.40	5051.71	5079.40	5080.74	5060.64	5045.21	5022.89	4994.75	4978.82	4971.59
G 45.0	5558.23	5554.34	5558.23	5562.27	5549.71	5503.39	5469.03	5449.88	5409.50	5390.20
G 50.0	6000.89	6025.21	6000.89	6008.50	6022.12	5948.32	5908.65	5916.46	5874.01	5848.73
G 55.0	6272.86	6301.46	6272.86	6251.88	6226.06	6183.30	6188.04	6220.38	6194.25	6170.86
G 60.0	6345.51	6334.15	6345.51	6360.26	6378.39	6286.83	6272.50	6311.93	6321.36	6292.07
G 65.0	6159.64	6142.84	6159.64	6120.87	6067.10	6090.13	6108.16	6110.29	6143.99	6151.60
G 70.0	5300.63	5165.91	5300.63	5348.09	5308.33	5261.97	5264.56	5323.60	5406.58	5485.23
G 75.0	4213.28	4064.93	4213.28	4151.10	4021.36	4151.63	4227.50	4179.82	4254.60	4309.44
G 80.0	2319.36	2444.21	2319.36	2530.64	2780.70	2495.55	2454.81	2726.77	2591.14	2383.15
G 85.0	1795.89	1847.85	1795.89	1784.07	1790.93	1760.93	1743.89	1753.27	1753.70	1764.39
G 90.0	0.00	0.00	0.00	0.00	0.00	0.00	0.00	0.00	0.00	0.00

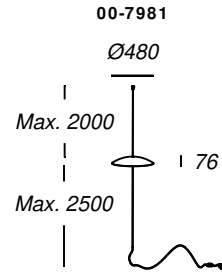
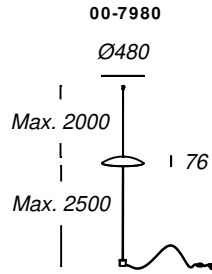
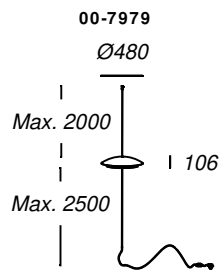
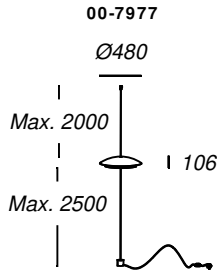

1

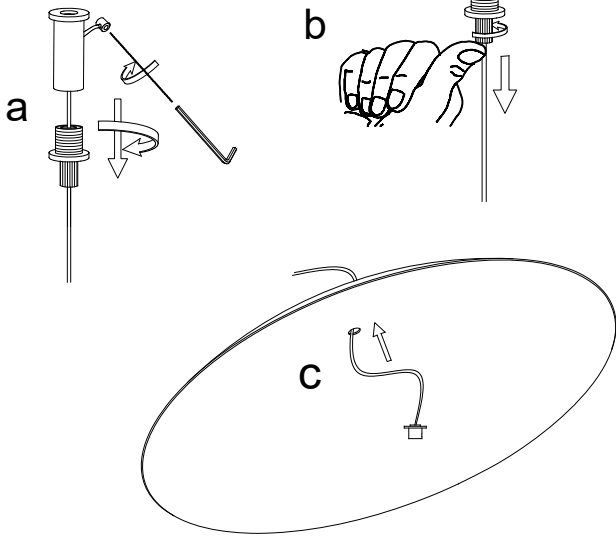

2

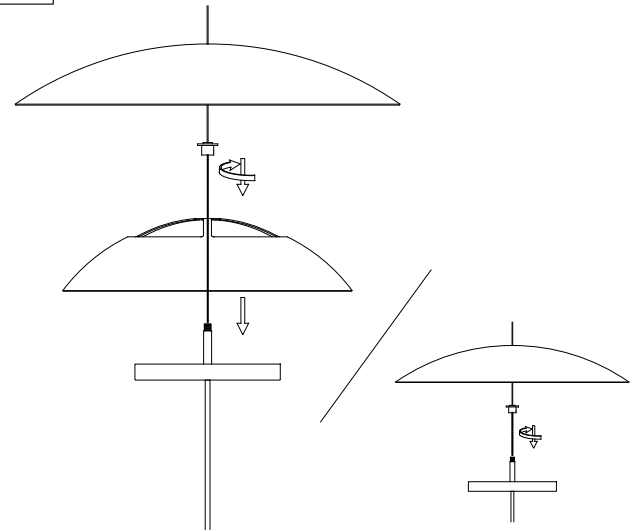

3

