





Noway Single Screen Floor lamp

Designer: Francesc Vilaró

Description

Floor lamp Noway Single Screen LED 18W 3000K Metallic black 791lm

	Finish	Material
Structure	Metallic black	Steel

 IP20
  HORIZONTAL 125°
  1

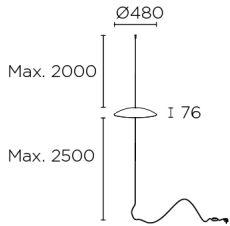

TECHNICAL CHARACTERISTICS

Light source

Light source: LED EDISON
 Light source power (W): 18W
 Luminaire total power (W): 18W
 Color temperature: LED warm-white
 3000K
 CRI: 80
 Photobiological risk: RG0
 Real Lumen: 791
 Qty Leds: 44
 Lm/Real W: 44
 Life Time: 50.000h L80B20
 Bin / Grup: 303
 MacAdam steps: 3
 UGR: 20.4
 Luminance C0°65°: 8836
 Luminance 90°65°: 8529.5

GEAR

Gear included: Yes, electronic
 Voltage / Frequency:
 220-240V/50-60Hz

Luminaire

Warranty: 5 Years

Logistics

Energy Efficiency: LED A++
 EAN Code: 8435575346963
 Net Weight (Kg): 3.38
 Weight in Kg (packaged): 5.67
 Masterbox: 1

The photograph may not match the reference exactly. Please read the product description to identify the finish.

LEDS C4[®]

Luminaire

Code 00-7981-05-05
Name LIAR

Measurement

Code 00-7981-05-05
Name LIAR

Luminaire Flux	791.14 lm	Luminaire Power	18.00 W	Efficacy	43.95 lm/W	Efficiency	100.00%
Sources Flux	791.14 lm	Maximum value	317.51 cd/klm	Position	C=0.00 G=0.00	CG	Double Symmetrical
Round Luminaire		Diam.	480 mm	Height	70 mm		
Round Luminous Area		Diam.	200 mm	Height	0 mm		
Horizontal Luminous Area		0.031416 m ²		Emitting area on Plane 180°		0.000000 m ²	
Emitting area on Plane 0°		0.000000 m ²		Emitting area on Plane 270°		0.000000 m ²	
Emitting area on Plane 90°		0.000000 m ²		Glare area at 76°		0.007600 m ²	
Coordinate system		CG		Symmetry Type		Double Symmetrical	
Date		24-10-2019		Maximum Gamma Angle		90	
Measurement Distance		0.00		Measurement Flux		791.14 lm	
Operator		Asselum T2		Rated Voltage			
Temperature		25.00 °C		Rated Current			
Humidity		60.00 %		Photocell			
Notes							

Line		Code		Luminaire Lamps		Flux [lm]	Pow. [W]	Q.ty
		00-7981-05-05		00-7980-DN-DN		791.14	18.00	1
C.I.E.	44 78 97 100 100			D DIN 5040	A30			
F UTE	1.00 E			B NBN	BZ 5 / 3 / BZ 4			

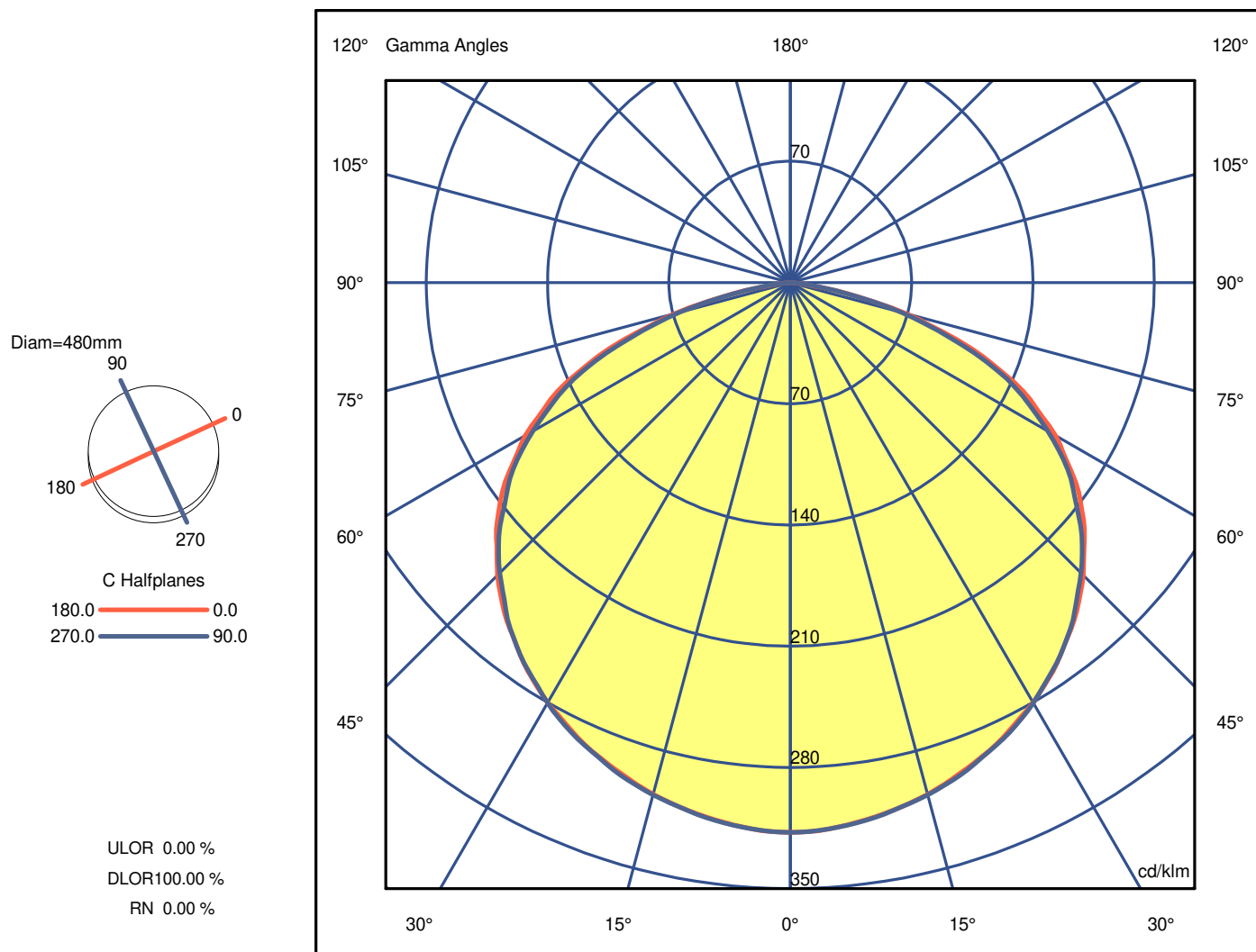

LEDS C4⁺

Luminaire

Code 00-7981-05-05
Name LIAR

Measurem.

Code 00-7981-05-05
Name LIAR

Luminaire Flux	791.14 lm	Luminaire Power	18.00 W	Efficacy	43.95 lm/W	Efficiency	100.00%
Sources Flux	791.14 lm	Maximum value	317.51 cd/klm	Position	C=0.00 G=0.00	CG	Double Symmetrical

Luminous Intensity Table cd/klm Table 1/1

	C 0.00	C 15.00	C 30.00	C 45.00	C 60.00	C 75.00	C 90.00
G 0.0	317.51	317.51	317.51	317.51	317.51	317.51	317.51
G 2.5	317.07	317.09	316.79	317.17	316.95	317.03	316.94
G 5.0	315.57	315.60	315.41	315.82	315.58	315.67	315.72
G 7.5	313.55	313.75	313.57	313.98	313.77	313.85	313.95
G 10.0	311.42	311.65	311.37	311.43	311.20	311.75	311.69
G 12.5	308.77	309.05	308.66	308.92	308.56	309.20	308.83
G 15.0	305.89	305.68	305.80	305.86	305.45	306.22	306.20
G 17.5	302.20	302.21	302.31	302.73	302.27	302.80	302.95
G 20.0	298.28	298.68	298.70	298.78	298.40	299.30	299.25
G 22.5	294.42	294.68	294.41	294.88	294.50	295.23	294.70
G 25.0	289.98	289.82	289.90	290.31	289.78	290.61	290.62
G 27.5	284.78	284.84	284.98	285.47	285.26	285.29	285.83
G 30.0	280.02	279.75	279.40	279.68	279.86	280.33	280.19
G 32.5	274.23	274.23	273.76	274.37	274.04	274.55	273.81
G 35.0	268.26	267.57	267.59	267.95	267.13	268.13	267.97
G 37.5	261.06	260.66	261.11	261.45	260.89	260.61	261.09
G 40.0	254.65	254.17	254.05	253.72	253.03	253.95	253.71
G 42.5	246.87	246.61	246.76	246.75	245.71	245.75	244.97
G 45.0	238.88	238.14	238.82	238.32	236.70	237.76	237.15
G 47.5	229.64	229.11	230.03	229.76	228.31	227.63	228.35
G 50.0	221.37	220.79	220.04	219.64	218.26	218.85	218.62
G 52.5	211.42	210.84	210.61	210.63	209.21	208.27	207.30
G 55.0	201.03	199.48	200.03	198.87	197.12	197.62	197.46
G 57.5	188.06	187.26	188.52	187.90	186.08	184.46	185.28
G 60.0	176.68	175.52	174.72	174.19	172.45	172.63	171.42
G 62.5	161.48	162.25	161.00	161.55	159.86	157.90	157.08
G 65.0	148.29	146.16	146.64	145.30	143.40	144.34	143.14
G 67.5	129.48	128.79	129.20	129.30	127.36	125.86	125.97
G 70.0	111.33	110.48	108.94	108.32	106.31	108.00	105.62
G 72.5	88.47	88.84	87.08	89.01	87.78	84.52	85.49
G 75.0	69.35	66.18	67.75	66.42	65.50	66.16	66.25
G 77.5	45.67	44.99	46.82	46.47	46.49	42.57	44.72
G 80.0	27.11	26.26	26.24	24.68	26.58	24.58	25.98
G 82.5	11.12	11.01	12.67	11.04	13.37	9.90	12.51
G 85.0	5.19	4.04	5.08	4.33	5.30	3.95	5.39
G 87.5	2.21	2.08	2.41	2.59	2.55	2.07	2.03
G 90.0	1.44	1.35	1.65	1.83	1.67	1.24	1.12

LEDS C4²

Luminaire

Code 00-7981-05-05
Name LIAR

Measurement

Code 00-7981-05-05
Name LIAR

Luminaire Flux	791.14 lm	Luminaire Power	18.00 W	Efficacy	43.95 lm/W	Efficiency	100.00%
Sources Flux	791.14 lm	Maximum value	317.51 cd/klm	Position	C=0.00 G=0.00	CG	Double Symmetrical

Diam=480mm

C Halfplanes

180.0 ———— 0.0
270.0 ———— 90.0

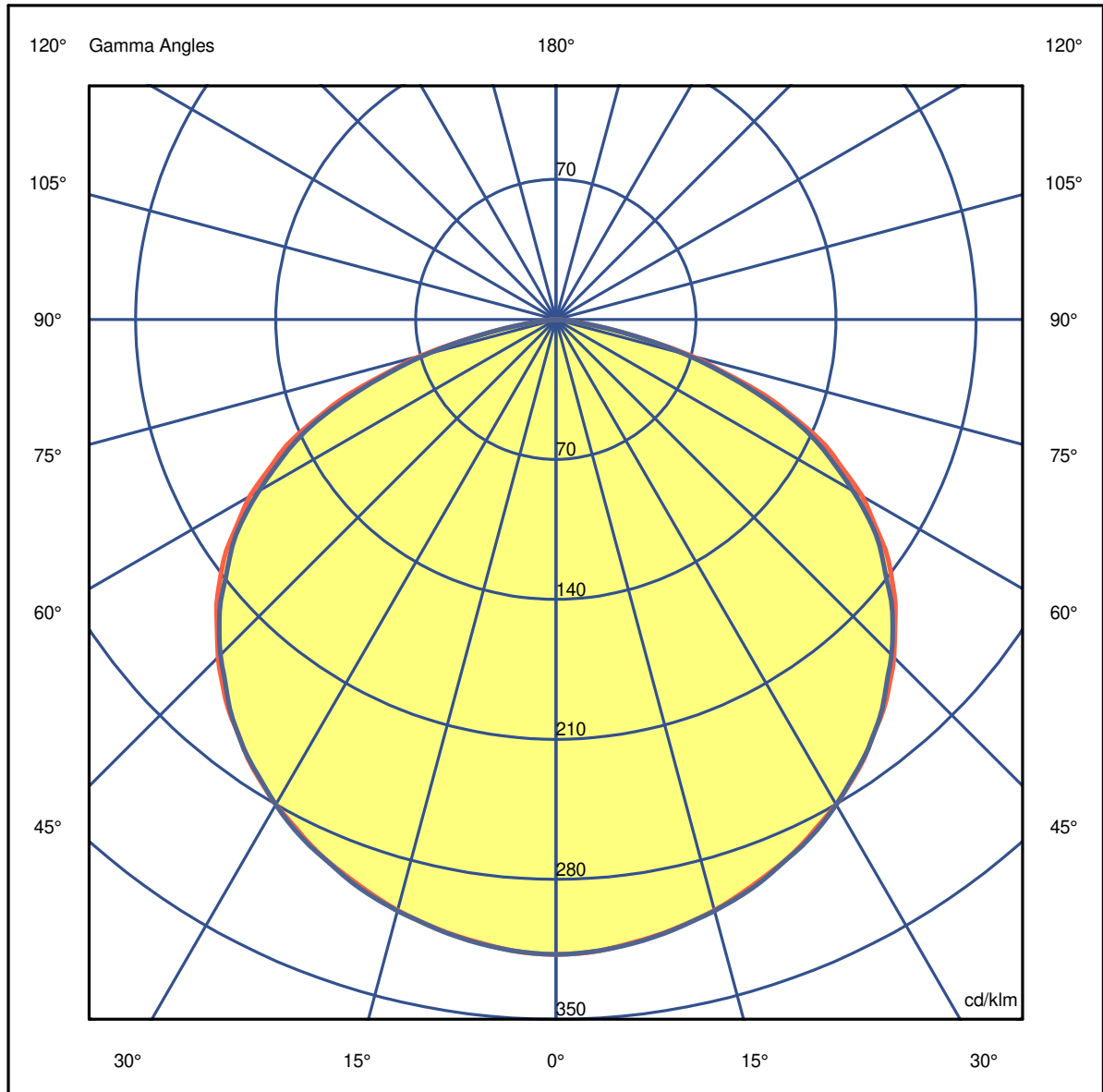
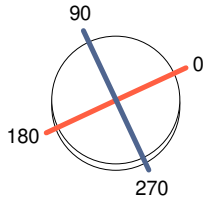

LEDS C4[®]

Luminaire

Code 00-7981-05-05
Name LIAR

Measurement

Code 00-7981-05-05
Name LIAR

Luminaire Flux	791.14 lm	Luminaire Power	18.00 W	Efficacy	43.95 lm/W	Efficiency	100.00%
Sources Flux	791.14 lm	Maximum value	317.51 cd/klm	Position	C=0.00 G=0.00	CG	Double Symmetrical

Diam=480mm

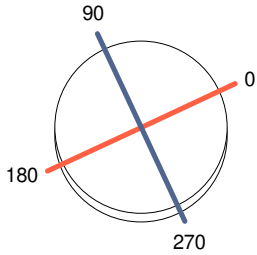

C Halfplanes

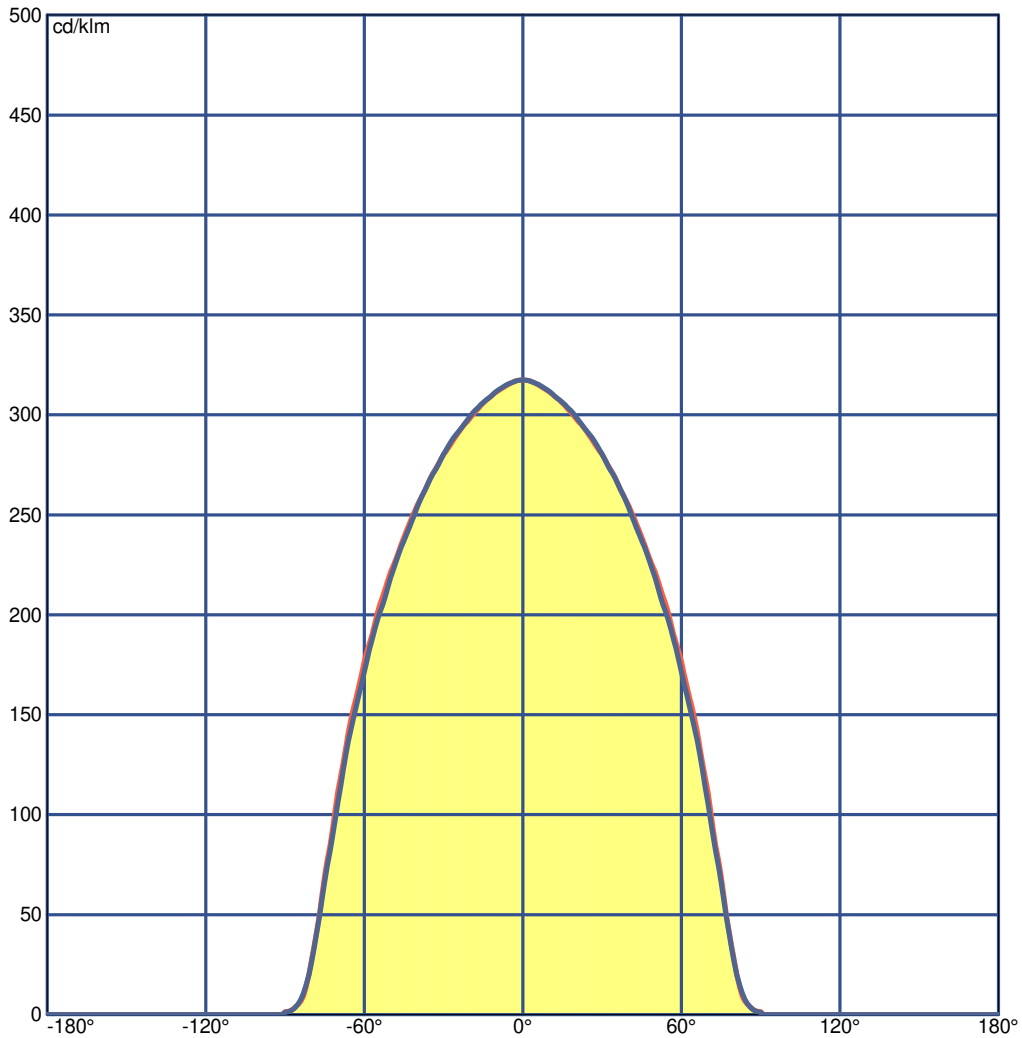

LEDS C4²

Luminaire

Code 00-7981-05-05
Name LIAR

Measurement

Code 00-7981-05-05
Name LIAR

Luminaire Flux	791.14 lm	Luminaire Power	18.00 W	Efficacy	43.95 lm/W	Efficiency	100.00%
Sources Flux	791.14 lm	Maximum value	317.51 cd/klm	Position	C=0.00 G=0.00	CG	Double Symmetrical

UGR
S = 0.250

Reflectancies										
Ceiling/Cavity	0.7	0.7	0.5	0.5	0.3	0.7	0.7	0.5	0.5	0.3
Walls	0.5	0.3	0.5	0.3	0.3	0.5	0.3	0.5	0.3	0.3
WorkingPlane	0.2	0.2	0.2	0.2	0.2	0.2	0.2	0.2	0.2	0.2
RoomDimensions	Viewed Crosswise					Viewed Endwise				
x=2H y=2H	20.4	21.7	20.7	21.9	22.2	20.3	21.6	20.6	21.8	22.1
x=2H y=3H	22.1	23.4	22.5	23.6	23.9	22.0	23.3	22.3	23.5	23.8
x=2H y=4H	22.7	23.9	23.0	24.1	24.4	22.6	23.7	22.9	24.0	24.3
x=2H y=6H	22.9	24.0	23.3	24.3	24.6	22.8	23.8	23.1	24.1	24.5
x=2H y=8H	22.9	24.0	23.3	24.3	24.6	22.8	23.8	23.1	24.1	24.4
x=2H y=12H	22.9	23.9	23.3	24.2	24.5	22.7	23.7	23.1	24.1	24.4
x=4H y=2H	21.2	22.4	21.6	22.7	23.0	21.1	22.3	21.5	22.6	22.9
x=4H y=3H	23.1	24.1	23.5	24.4	24.8	23.0	24.0	23.4	24.3	24.6
x=4H y=4H	23.7	24.6	24.1	25.0	25.3	23.6	24.5	24.0	24.8	25.2
x=4H y=6H	24.0	24.8	24.5	25.2	25.6	23.9	24.6	24.3	25.0	25.4
x=4H y=8H	24.1	24.8	24.5	25.2	25.6	23.9	24.6	24.4	25.0	25.4
x=4H y=12H	24.0	24.7	24.5	25.1	25.5	23.9	24.5	24.3	24.9	25.4
x=8H y=4H	24.0	24.7	24.5	25.1	25.5	23.9	24.6	24.3	25.0	25.4
x=8H y=6H	24.4	24.9	24.8	25.4	25.8	24.2	24.8	24.7	25.2	25.7
x=8H y=8H	24.4	24.9	24.9	25.3	25.8	24.3	24.8	24.7	25.2	25.7
x=8H y=12H	24.4	24.8	24.9	25.3	25.8	24.3	24.7	24.7	25.1	25.7
x=12H y=4H	24.0	24.6	24.4	25.0	25.5	23.9	24.5	24.3	24.9	25.4
x=12H y=6H	24.4	24.8	24.8	25.3	25.8	24.2	24.7	24.7	25.2	25.6
x=12H y=8H	24.4	24.8	24.9	25.3	25.8	24.3	24.7	24.8	25.2	25.7

LEDS C4[®]

Luminaire

Code 00-7981-05-05
Name LIAR

Measurerm.

Code 00-7981-05-05
Name LIAR

Luminaire Flux	791.14 lm	Luminaire Power	18.00 W	Efficacy	43.95 lm/W	Efficiency	100.00%
Sources Flux	791.14 lm	Maximum value	317.51 cd/klm	Position	C=0.00 G=0.00	CG	Double Symmetrical

Total Flux=791.14 Luminaire Flux=791.14

RI	0.60	0.80	1.00	1.25	1.50	2.00	2.50	3.00	4.00	5.00	10.00	20.00
DRR	0.28	0.37	0.45	0.52	0.58	0.67	0.73	0.78	0.83	0.86	0.93	0.97
RC	6	5	5	5	5	5	5	5	5	5	4	4

Zonal Flux per 1000 Lumen

Y°	10	20	30	40	50	60	70	80	90	100	110	120	130	140	150	160	170	180
ZF(Y)	30	116	250	418	602	779	921	991	1000	1000	1000	1000	1000	1000	1000	1000	1000	1000

CIE Flux Codes

44 78 97 100 100

C.I.E.	6/5/5/5/5/5/5/5/4/4	LOR	100.00000 %
D DIN 5040	A30	ULOR	0.00000 %
F UTE	1.00 E	DLOR	100.00000 %
B NBN	BZ 5 / 3 / BZ 4	UFF	0.00000 %
RN	0.00000 %	DFF	100.00000 %
BLF	1.0	FFR	0.00000 %

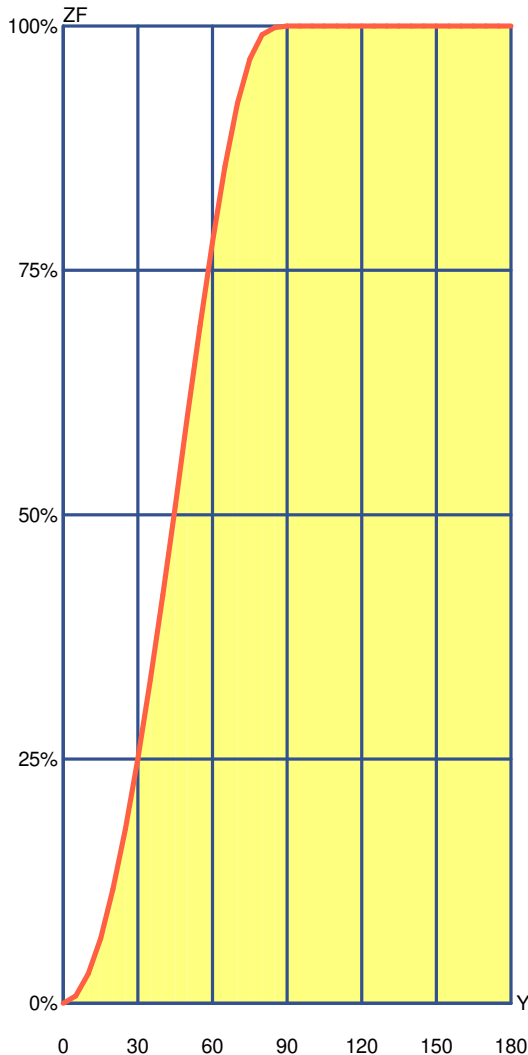

Gamma °	Zonal Flux			
	Flux	Sum lm	Flux [%]	Sum [%]
0°	0.00	0.00	0.00%	0.00 %
5°	7.57	7.57	0.76 %	0.76 %
10°	22.43	30.00	2.24 %	3.00 %
15°	36.62	66.61	3.66 %	6.66 %
20°	49.82	116.44	4.98 %	11.64 %
25°	61.77	178.20	6.18 %	17.82 %
30°	72.13	250.33	7.21 %	25.03 %
35°	80.66	330.99	8.07 %	33.10 %
40°	87.02	418.01	8.70 %	41.80 %
45°	91.09	509.10	9.11 %	50.91 %
50°	92.46	601.56	9.25 %	60.16 %
55°	91.06	692.62	9.11 %	69.26 %
60°	86.21	778.84	8.62 %	77.88 %
65°	77.73	856.56	7.77 %	85.66 %
70°	64.49	921.06	6.45 %	92.11 %
75°	45.68	966.74	4.57 %	96.67 %
80°	24.50	991.23	2.45 %	99.12 %
85°	7.29	998.53	0.73 %	99.85 %
90°	1.47	1000.00	0.15 %	100.00 %
95°	0.00	1000.00	0.00 %	100.00 %
100°	0.00	1000.00	0.00 %	100.00 %
105°	0.00	1000.00	0.00 %	100.00 %
110°	0.00	1000.00	0.00 %	100.00 %
115°	0.00	1000.00	0.00 %	100.00 %
120°	0.00	1000.00	0.00 %	100.00 %
125°	0.00	1000.00	0.00 %	100.00 %
130°	0.00	1000.00	0.00 %	100.00 %
135°	0.00	1000.00	0.00 %	100.00 %
140°	0.00	1000.00	0.00 %	100.00 %
145°	0.00	1000.00	0.00 %	100.00 %
150°	0.00	1000.00	0.00 %	100.00 %
155°	0.00	1000.00	0.00 %	100.00 %
160°	0.00	1000.00	0.00 %	100.00 %
165°	0.00	1000.00	0.00 %	100.00 %
170°	0.00	1000.00	0.00 %	100.00 %
175°	0.00	1000.00	0.00 %	100.00 %
180°	0.00	1000.00	0.00 %	100.00 %

LEDS C4[®]

Luminaire

Code 00-7981-05-05

Name LIAR

Measurement

Code 00-7981-05-05

Name LIAR

Luminaire Flux	791.14 lm	Luminaire Power	18.00 W	Efficacy	43.95 lm/W	Efficiency	100.00%
Sources Flux	791.14 lm	Maximum value	317.51 cd/klm	Position	C=0.00 G=0.00	CG	Double Symmetrical

Utilizations CIE

Mounting	Direct	Normalization		Normalised		Suspension Ratid/3						Standard CIE Settings											
Ceiling																							
K	8873	8773	8871	8771	7773	7771	7753	7553	7751	7551	7731	7331	7711	7111	5551	5531	5331	5511	5111	3331	3311	1111	0000
0.60	220	198	175	158	188	151	112	95	89	76	47	36	17	12	71	38	34	14	11	32	12	10	0
0.80	255	234	187	172	222	165	141	123	102	90	57	45	23	17	84	47	43	20	16	41	17	15	0
1.00	277	258	189	177	245	169	164	146	109	98	64	53	29	22	92	54	50	25	21	47	22	20	0
1.25	297	280	186	176	266	169	187	170	113	104	70	60	36	29	97	61	57	31	27	54	28	25	0
1.50	311	295	181	173	281	166	206	190	115	107	75	65	41	34	101	66	62	37	33	59	33	30	0
2.00	327	315	169	163	300	158	234	219	116	109	81	72	51	44	103	73	69	46	42	66	42	39	0
2.50	338	327	159	155	313	150	255	241	115	110	85	78	58	52	104	77	74	54	50	71	50	46	0
3.00	346	336	152	149	321	144	270	258	114	110	88	81	64	58	105	81	78	60	56	75	56	52	0
4.00	356	349	142	140	334	136	292	281	113	110	92	87	72	67	105	86	83	68	65	81	64	61	0
5.00	363	357	136	134	342	131	307	298	112	109	94	90	78	73	105	89	87	74	71	84	70	67	0
10.00	377	374	122	122	359	120	340	335	110	108	100	98	91	88	105	96	95	88	86	93	85	82	0
20.00	385	384	115	114	369	113	359	356	108	107	104	102	99	97	105	100	100	96	95	97	93	91	0

Wall

K	8873	8773	8871	8771	7773	7771	7753	7553	7751	7551	7731	7331	7711	7111	5551	5531	5331	5511	5111	3331	3311	1111	0000
0.60	478	466	421	413	459	408	362	354	329	324	276	272	238	236	321	272	270	236	235	270	236	235	215
0.80	538	525	460	452	516	446	420	411	372	366	319	314	280	277	362	314	312	278	276	311	276	275	252
1.00	578	565	482	474	553	467	461	451	399	393	349	343	309	306	388	343	340	307	305	338	305	304	277
1.25	611	599	496	490	585	482	499	488	422	416	374	368	336	333	409	367	365	333	331	362	331	329	299
1.50	635	623	504	499	607	491	527	516	436	431	392	387	356	352	423	385	382	353	350	379	349	347	314
2.00	656	646	502	498	627	491	559	548	446	441	408	403	377	372	432	400	398	372	369	393	368	364	328
2.50	667	659	497	494	638	486	578	567	448	445	416	411	388	384	435	407	405	382	380	399	377	373	334
3.00	672	664	490	487	642	479	589	579	447	444	419	414	394	389	434	409	407	387	385	401	382	377	335
4.00	681	674	482	480	650	473	607	598	448	445	425	421	404	400	434	415	413	397	394	406	390	384	339
5.00	686	681	477	476	655	469	618	611	448	445	428	425	411	407	435	418	416	402	400	408	395	388	342
10.00	687	683	455	454	655	448	634	629	436	435	426	424	416	413	424	414	413	405	404	404	396	387	337
20.00	662	661	418	418	630	411	620	617	406	405	400	399	395	393	393	389	388	384	383	377	373	363	311

Working Pl.

K	8873	8773	8871	8771	7773	7771	7753	7553	7751	7551	7731	7331	7711	7111	5551	5531	5331	5511	5111	3331	3311	1111	0000
0.60	578	565	539	529	557	523	438	431	422	416	354	349	304	302	412	349	347	303	302	346	302	301	283
0.80	688	674	634	624	662	616	543	532	518	510	447	441	395	392	504	441	439	392	391	436	391	389	371
1.00	775	760	706	697	744	687	629	617	595	587	526	519	473	469	579	518	515	469	467	511	467	465	446
1.25	857	842	772	764	822	752	714	700	668	661	603	596	551	546	650	593	590	547	544	585	543	540	522
1.50	918	904	820	813	881	800	779	765	724	717	663	655	613	607	704	651	648	607	604	642	602	598	581
2.00	1000	994	887	881	967	869	879	865	806	799	753	745	709	702	785	740	737	701	697	728	694	688	672
2.50	1000	1000	929	924	1000	911	946	932	858	853	813	805	773	766	837	798	795	763	760	785	755	748	733
3.00	1000	1000	957	953	1000	940	994	981	895	890	855	848	820	813	873	839	836	809	805	825	799	790	776
4.00	1000	1000	991	988	1000	975	1000	1000	940	936	908	902	879	872	917	890	888	866	862	875	854	843	830
5.00	1000	1000	1000	1000	1000	996	1000	1000	967	964	940	935	916	909	944	922	920	901	897	905	888	876	863
10.00	1000	1000	1000	1000	1000	1000	1000	1000	1000	1000	1000	1000	994	990	1000	988	986	976	974	969	959	944	933
20.00	1000	1000	1000	1000	1000	1000	1000	1000	1000	1000	1000	1000	1000	1000	1000	1000	1000	1000	1000	1000	997	979	969

LM53 SHR C0-C180: 1.311 SHR C90-C270: 1.311 SHR Square: 1.463

LEDS C4[®]

Luminaire

Code 00-7981-05-05
Name LIAR

Measurem.

Code 00-7981-05-05
Name LIAR

Luminaire Flux	791.14 lm	Luminaire Power	18.00 W	Efficacy	43.95 lm/W	Efficiency	100.00%
Sources Flux	791.14 lm	Maximum value	317.51 cd/klm	Position	C=0.00 G=0.00	CG	Double Symmetrical

Width at 50.00 % of Max Intensity

H[m]	1.00	2.00	3.00	4.00	5.00	H[m]	1.00	2.00	3.00	4.00	5.00
OA	1.96	3.93	5.89	7.86	9.82	OC	1.90	3.79	5.69	7.59	9.48
OB	1.96	3.93	5.89	7.86	9.82	OD	1.90	3.79	5.69	7.59	9.48

	Luminous Intensities [cd/klm]									
	0	5	15	25	35	45	55	65	75	85
OA	251.19	249.66	242.00	229.42	212.23	188.98	159.04	117.31	54.86	4.11
OB	251.19	249.66	242.00	229.42	212.23	188.98	159.04	117.31	54.86	4.11
OC	251.19	249.78	242.25	229.92	212.00	187.62	156.22	113.25	52.41	4.27
OD	251.19	249.78	242.25	229.92	212.00	187.62	156.22	113.25	52.41	4.27

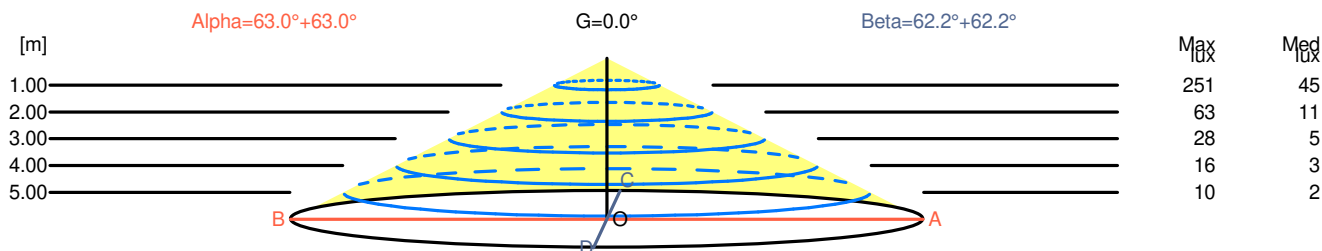

H[m]	D[m]	Max lux	Med lux	Alpha=63.0°+63.0°	G=0.0
1.00	3.93	251	45		
2.00	7.86	63	11		
3.00	11.78	28	5		
4.00	15.71	16	3		
5.00	19.64	10	2		

H[m]	D[m]	Max lux	Med lux	Beta=62.2°+62.2°	G=0.0
1.00	3.79	251	45		
2.00	7.59	63	11		
3.00	11.38	28	5		
4.00	15.18	16	3		
5.00	18.97	10	2		

LEDS C4⁺

Luminaire

Code 00-7981-05-05

Name LIAR

Measur.

Code 00-7981-05-05

Name LIAR

Luminaire Flux	791.14 lm	Luminaire Power	18.00 W	Efficacy	43.95 lm/W	Efficiency	100.00%
Sources Flux	791.14 lm	Maximum value	317.51 cd/klm	Position	C=0.00 G=0.00	CG	Double Symmetrical

Isolux (Floor)

Luminaire position X=0.00m Y=0.00m Z=2.50m

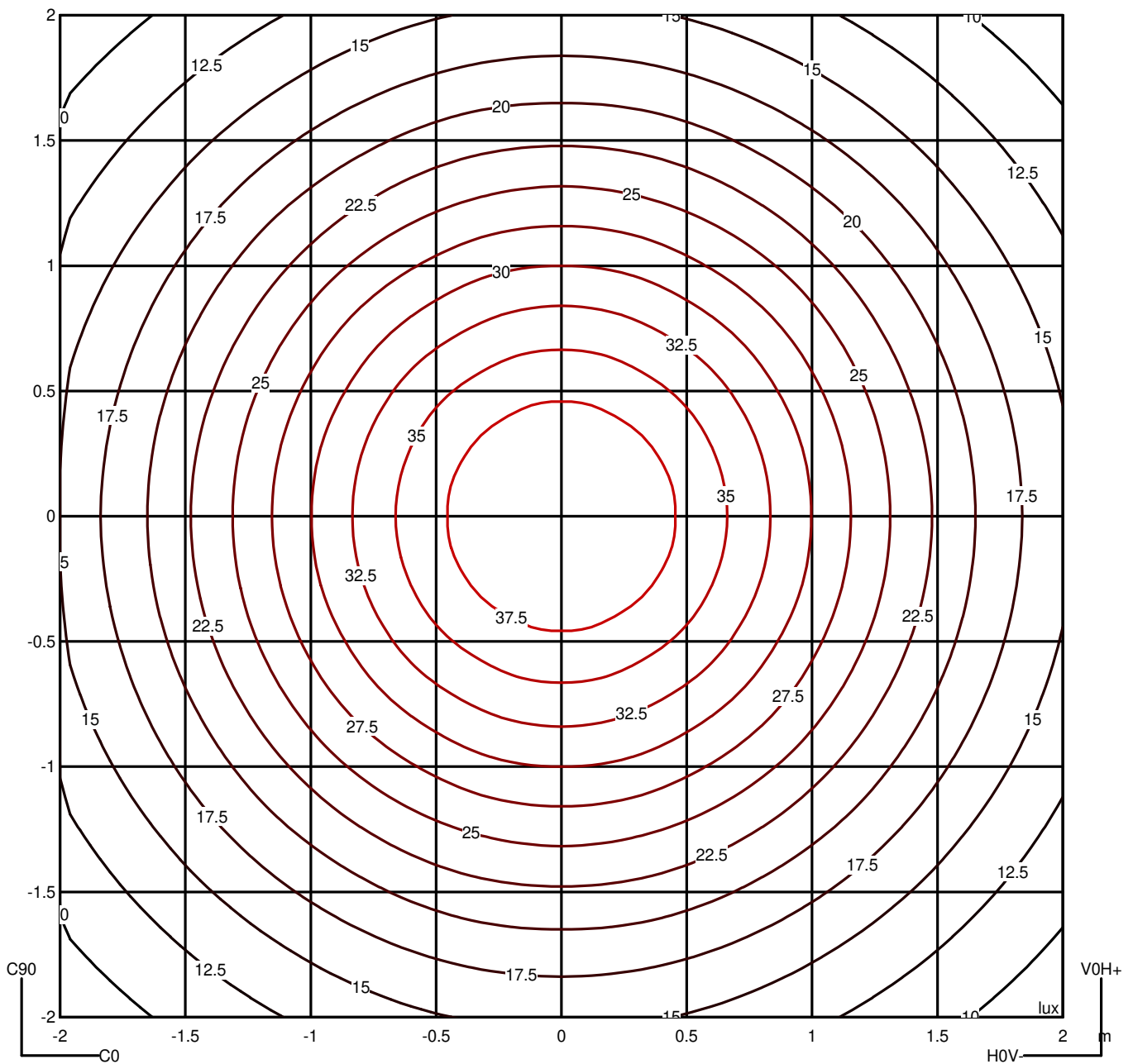

LEDS C4²

Luminaire

Code 00-7981-05-05
Name LIAR

Measurem.

Code 00-7981-05-05
Name LIAR

Luminaire Flux	791.14 lm	Luminaire Power	18.00 W	Efficacy	43.95 lm/W	Efficiency	100.00%
Sources Flux	791.14 lm	Maximum value	317.51 cd/klm	Position	C=0.00 G=0.00	CG	Double Symmetrical

Luminance

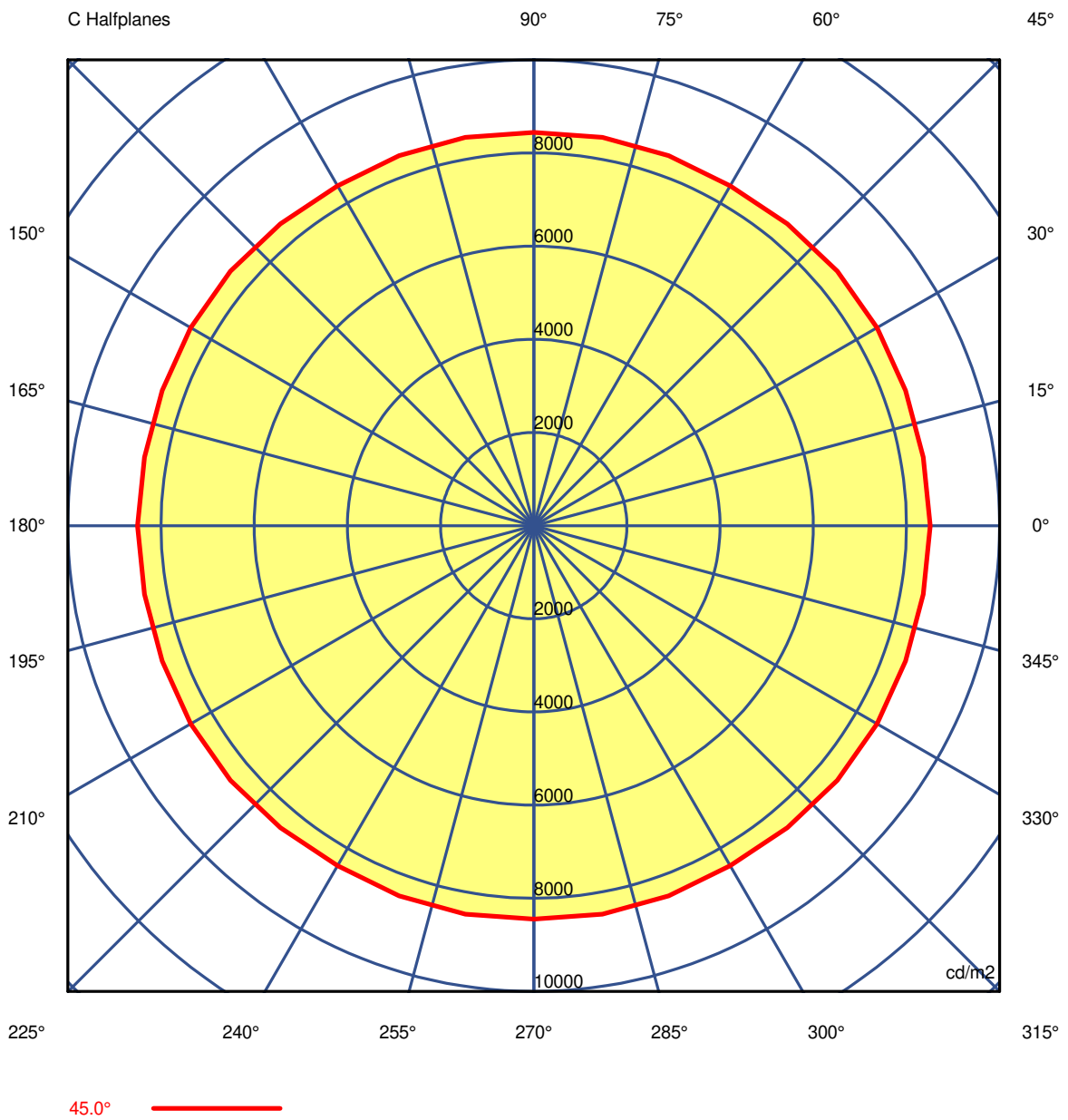

LEDS C4⁺

Luminaire

Code 00-7981-05-05

Name LIAR

Measurement

Code 00-7981-05-05

Name LIAR

Luminaire Flux	791.14 lm	Luminaire Power	18.00 W	Efficacy	43.95 lm/W	Efficiency	100.00%
Sources Flux	791.14 lm	Maximum value	317.51 cd/klm	Position	C=0.00 G=0.00	CG	Double Symmetrical

Luminance cd/m2 Table 1/3

	C 0.00	C 10.00	C 20.00	C 30.00	C 40.00	C 50.00	C 60.00	C 70.00	C 80.00	C 90.00	C 100.00	C 110.00	C 120.00
G 0.0	7995.76	7995.76	7995.76	7995.76	7995.76	7995.76	7995.76	7995.76	7995.76	7995.76	7995.76	7995.76	7995.76
G 5.0	7977.38	7978.89	7976.41	7973.20	7980.83	7982.90	7977.54	7978.35	7980.26	7981.07	7980.26	7978.35	7977.54
G 10.0	7963.35	7968.91	7967.14	7962.04	7963.55	7961.25	7957.87	7967.07	7973.49	7970.37	7973.49	7967.07	7957.87
G 15.0	7974.79	7970.37	7969.50	7972.61	7975.62	7970.49	7963.39	7976.49	7986.34	7982.99	7986.34	7976.49	7963.39
G 20.0	7993.62	8001.87	8004.73	8004.82	8007.99	8003.60	7996.81	8012.59	8023.96	8019.64	8023.96	8012.59	7996.81
G 25.0	8057.50	8054.34	8052.05	8055.16	8065.59	8061.72	8051.96	8066.29	8074.95	8075.27	8074.95	8066.29	8051.96
G 30.0	8142.57	8137.97	8130.25	8124.57	8129.43	8134.30	8137.84	8147.68	8152.15	8147.43	8152.15	8147.68	8137.84
G 35.0	8246.93	8231.22	8222.71	8226.30	8237.86	8228.48	8212.27	8231.57	8246.47	8237.96	8246.47	8231.57	8212.27
G 40.0	8371.38	8359.63	8353.20	8351.49	8347.17	8330.37	8318.18	8338.08	8351.03	8340.53	8351.03	8338.08	8318.18
G 45.0	8507.30	8484.31	8486.66	8505.25	8502.41	8464.32	8429.94	8453.66	8468.93	8445.87	8468.93	8453.66	8429.94
G 50.0	8672.78	8659.02	8639.03	8620.79	8614.52	8585.63	8550.84	8563.67	8576.56	8564.81	8576.56	8563.67	8550.84
G 55.0	8826.07	8770.00	8762.46	8782.14	8758.32	8699.69	8654.54	8669.12	8679.58	8669.47	8679.58	8669.12	8654.54
G 60.0	8898.64	8858.97	8823.17	8799.90	8789.40	8742.99	8685.57	8690.47	8684.44	8633.90	8684.44	8690.47	8685.57
G 65.0	8835.96	8733.66	8711.61	8738.06	8700.54	8608.48	8544.66	8582.10	8594.05	8529.49	8594.05	8582.10	8544.66
G 70.0	8197.24	8163.85	8093.75	8020.99	8002.46	7916.83	7827.30	7915.78	7931.25	7776.47	7931.25	7915.78	7827.30
G 75.0	6747.54	6488.85	6470.54	6591.72	6528.61	6411.07	6372.96	6413.39	6440.00	6445.64	6440.00	6413.39	6372.96
G 80.0	3932.13	3826.59	3807.21	3805.42	3611.52	3661.98	3853.96	3664.28	3564.03	3767.65	3564.03	3664.28	3853.96
G 85.0	1500.02	1195.67	1259.52	1468.61	1300.83	1336.50	1530.25	1257.66	1177.37	1557.69	1177.37	1257.66	1530.25
G 90.0	0.00	0.00	0.00	0.00	0.00	0.00	0.00	0.00	0.00	0.00	0.00	0.00	0.00

LEDS C4⁺

Luminaire

Code 00-7981-05-05
Name LIAR

Measurement

Code 00-7981-05-05
Name LIAR

Luminaire Flux	791.14 lm	Luminaire Power	18.00 W	Efficacy	43.95 lm/W	Efficiency	100.00%
Sources Flux	791.14 lm	Maximum value	317.51 cd/klm	Position	C=0.00 G=0.00	CG	Double Symmetrical

Luminance cd/m2 Table 2/3

	C 130.00	C 140.00	C 150.00	C 160.00	C 170.00	C 180.00	C 190.00	C 200.00	C 210.00	C 220.00	C 230.00	C 240.00	C 250.00
G 0.0	7995.76	7995.76	7995.76	7995.76	7995.76	7995.76	7995.76	7995.76	7995.76	7995.76	7995.76	7995.76	7995.76
G 5.0	7982.90	7980.83	7973.20	7976.41	7978.89	7977.38	7978.89	7976.41	7973.20	7980.83	7982.90	7977.54	7978.35
G 10.0	7961.25	7963.55	7962.04	7967.14	7968.91	7963.35	7968.91	7967.14	7962.04	7963.55	7961.25	7957.87	7967.07
G 15.0	7970.49	7975.62	7972.61	7969.50	7970.37	7974.79	7970.37	7969.50	7972.61	7975.62	7970.49	7963.39	7976.49
G 20.0	8003.60	8007.99	8004.82	8004.73	8001.87	7993.62	8001.87	8004.73	8004.82	8007.99	8003.60	7996.81	8012.59
G 25.0	8061.72	8065.59	8055.16	8052.05	8054.34	8057.50	8054.34	8052.05	8055.16	8065.59	8061.72	8051.96	8066.29
G 30.0	8134.30	8129.43	8124.57	8130.25	8137.97	8142.57	8137.97	8130.25	8124.57	8129.43	8134.30	8137.84	8147.68
G 35.0	8228.48	8237.86	8226.30	8222.71	8231.22	8246.93	8231.22	8222.71	8226.30	8237.86	8228.48	8212.27	8231.57
G 40.0	8330.37	8347.17	8351.49	8353.20	8359.63	8371.38	8359.63	8353.20	8351.49	8347.17	8330.37	8318.18	8338.08
G 45.0	8464.32	8502.41	8505.25	8486.66	8484.31	8507.30	8484.31	8486.66	8505.25	8502.41	8464.32	8429.94	8453.66
G 50.0	8585.63	8614.52	8620.79	8639.03	8659.02	8672.78	8659.02	8639.03	8620.79	8614.52	8585.63	8550.84	8563.67
G 55.0	8699.69	8758.32	8782.14	8762.46	8770.00	8826.07	8770.00	8762.46	8782.14	8758.32	8699.69	8654.54	8669.12
G 60.0	8742.99	8789.40	8799.90	8823.17	8858.97	8898.64	8858.97	8823.17	8799.90	8789.40	8742.99	8685.57	8690.47
G 65.0	8608.48	8700.54	8738.06	8711.61	8733.66	8835.96	8733.66	8711.61	8738.06	8700.54	8608.48	8544.66	8582.10
G 70.0	7916.83	8002.46	8020.99	8093.75	8163.85	8197.24	8163.85	8093.75	8020.99	8002.46	7916.83	7827.30	7915.78
G 75.0	6411.07	6528.61	6591.72	6470.54	6488.85	6747.54	6488.85	6470.54	6591.72	6528.61	6411.07	6372.96	6413.39
G 80.0	3661.98	3611.52	3805.42	3807.21	3826.59	3932.13	3826.59	3807.21	3805.42	3611.52	3661.98	3853.96	3664.28
G 85.0	1336.50	1300.83	1468.61	1259.52	1195.67	1500.02	1195.67	1259.52	1468.61	1300.83	1336.50	1530.25	1257.66
G 90.0	0.00	0.00	0.00	0.00	0.00	0.00	0.00	0.00	0.00	0.00	0.00	0.00	0.00

LEDS C4[®]

Luminaire

Code 00-7981-05-05

Name LIAR

Measur.

Code 00-7981-05-05

Name LIAR

Luminaire Flux	791.14 lm	Luminaire Power	18.00 W	Efficacy	43.95 lm/W	Efficiency	100.00%
Sources Flux	791.14 lm	Maximum value	317.51 cd/klm	Position	C=0.00 G=0.00	CG	Double Symmetrical

Luminance cd/m2 Table 3/3

	C 260.00	C 270.00	C 280.00	C 290.00	C 300.00	C 310.00	C 320.00	C 330.00	C 340.00	C 350.00
G 0.0	7995.76	7995.76	7995.76	7995.76	7995.76	7995.76	7995.76	7995.76	7995.76	7995.76
G 5.0	7980.26	7981.07	7980.26	7978.35	7977.54	7982.90	7980.83	7973.20	7976.41	7978.89
G 10.0	7973.49	7970.37	7973.49	7967.07	7957.87	7961.25	7963.55	7962.04	7967.14	7968.91
G 15.0	7986.34	7982.99	7986.34	7976.49	7963.39	7970.49	7975.62	7972.61	7969.50	7970.37
G 20.0	8023.96	8019.64	8023.96	8012.59	7996.81	8003.60	8007.99	8004.82	8004.73	8001.87
G 25.0	8074.95	8075.27	8074.95	8066.29	8051.96	8061.72	8065.59	8055.16	8052.05	8054.34
G 30.0	8152.15	8147.43	8152.15	8147.68	8137.84	8134.30	8129.43	8124.57	8130.25	8137.97
G 35.0	8246.47	8237.96	8246.47	8231.57	8212.27	8228.48	8237.86	8226.30	8222.71	8231.22
G 40.0	8351.03	8340.53	8351.03	8338.08	8318.18	8330.37	8347.17	8351.49	8353.20	8359.63
G 45.0	8468.93	8445.87	8468.93	8453.66	8429.94	8464.32	8502.41	8505.25	8486.66	8484.31
G 50.0	8576.56	8564.81	8576.56	8563.67	8550.84	8585.63	8614.52	8620.79	8639.03	8659.02
G 55.0	8679.58	8669.47	8679.58	8669.12	8654.54	8699.69	8758.32	8782.14	8762.46	8770.00
G 60.0	8684.44	8633.90	8684.44	8690.47	8685.57	8742.99	8789.40	8799.90	8823.17	8858.97
G 65.0	8594.05	8529.49	8594.05	8582.10	8544.66	8608.48	8700.54	8738.06	8711.61	8733.66
G 70.0	7931.25	7776.47	7931.25	7915.78	7827.30	7916.83	8002.46	8020.99	8093.75	8163.85
G 75.0	6440.00	6445.64	6440.00	6413.39	6372.96	6411.07	6528.61	6591.72	6470.54	6488.85
G 80.0	3564.03	3767.65	3564.03	3664.28	3853.96	3661.98	3611.52	3805.42	3807.21	3826.59
G 85.0	1177.37	1557.69	1177.37	1257.66	1530.25	1336.50	1300.83	1468.61	1259.52	1195.67
G 90.0	0.00	0.00	0.00	0.00	0.00	0.00	0.00	0.00	0.00	0.00

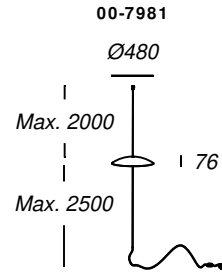
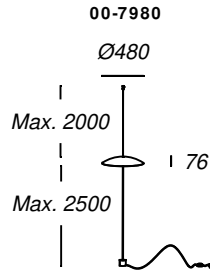
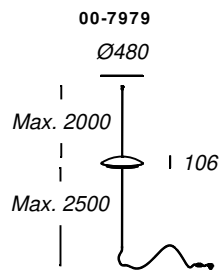
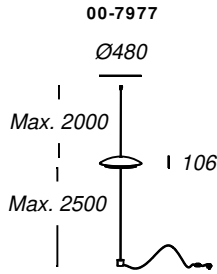

1

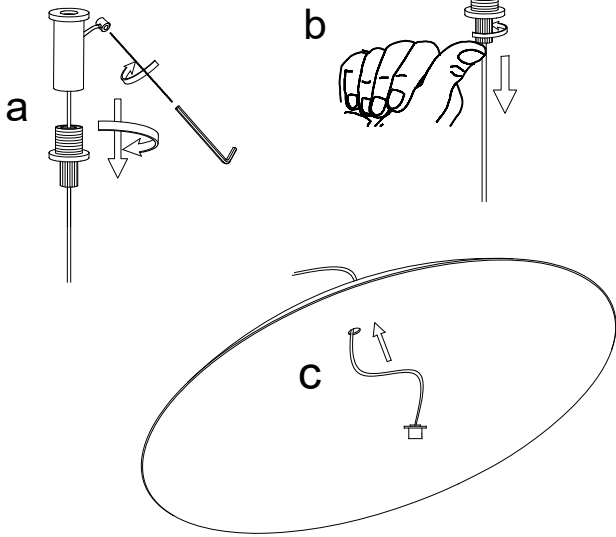

2

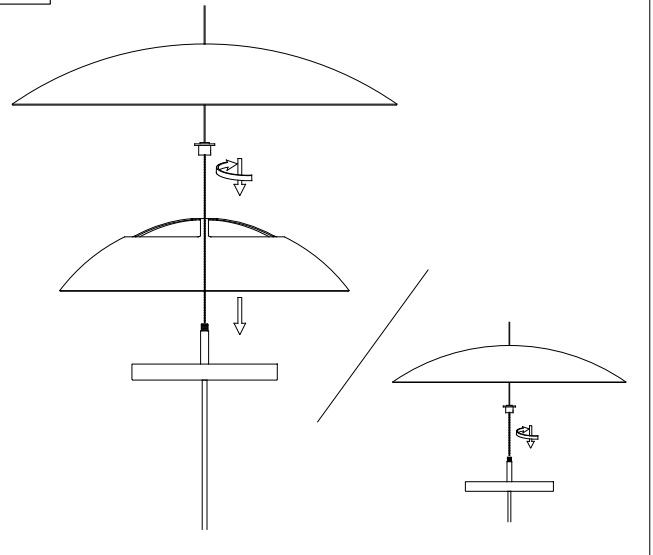

3

